



Kest-Lock

The super user friendly Aseptic quick connection for TriClamps - A time saver!

DS-000009 REV E

Kest-Lock - Just snap and tighten

Our patented Kest-lock design unites the advantages of a traditional TC-clamp with an aseptic tank or pipe connection, in a new innovative design.

Kest-Lock with the unique quick coupling don't require any tools, have no loose parts and can easily be operated with one hand.

Kest-Lock is developed for critical applications where aseptic design, easy and safe handling are essentials.

To suit your needs, we have developed a broad range of different flanges for the Kest-Lock rings.

For special requests of specific materials or tube standards of the flanges, please contact your reseller for a quote.

Kest-Lock is designed according to criteria of ASME BPE, in accordance to surface finish, material, clean ability, dimensions and aseptic design.

Kest-Lock are designed to fit to clamp ferrules according to ISO 2852, ASME BPE and DIN 32 676.

The Kest-Lock ring is available in two different types: The Snap and the Basic.

The Kest-Lock Snap with the unique snap function for one hand operation - the super user friendly aseptic connection.

The Kest-Lock Basic is a similar version for static connections, with no loose parts and are tightened from the side to not interfere with your devices.

General information

Standards

The Kest-Lock is available in most common pipe standard for the Pharmaceutical and Food industry. TC sizes from TC25 to TC119 (US ASTM 1/2" to 4").

ASTM A 269/270
 ISO 1127
 EN 10357 (DIN 11850)*
 SMS 3008
 JS IDF

*DIN 11850 has been replaced by EN 10357

Table of Content

See on what page you can find the product/ products you are searching for.

Kest-Lock Snap Ring	Page 4
Kest-Lock Basic Ring	Page 4
Kest-Lock Tank Flange	Page 7
Tank Flange welding tool	Page 24
Kest-Lock Pipe Flange	Page 25
Kest-Lock Pipe Adapter Flange	Page 29
Kest-Lock Pipe Panel Flange	Page 33
Kest-Lock Pipe Inline	Page 35
Kest-Lock Pipe Inline Double	Page 37
Blind TC with knob	Page 39

Product description

Kest-Lock Snap Ring	A unique user friendly connection that allows you to connect a TC device using only one hand, no tools required. Perfect if you need to connect and disconnect often.
Kest-Lock Basic Ring	A unique user friendly connection that allows you to connect a TC device in a very smart way. No loose parts and minimal overhead space required, perfect for static connections.
Kest-Lock Tank Flange	When you want to have a Kest-Lock connection on your tank you weld in the tank flange and attach the Kest-Lock Connection on it. Make sure you use our welding tools.
Kest-Lock Pipe Flange	When you want to have a Kest-Lock connection straight on a pipe you weld on the pipe flange and attach the Kest-Lock Connection on it.
Kest-Lock Pipe Adapter Flange	When you have two TC connections and want to use the Kest-Lock you attach the pipe adapter flange on one TC and attach the Kest-Lock to the pipe adapter flange.
Kest-Lock Pipe Panel Flange	When you want to have a Kest-Lock connection on a swing panel you weld on the pipe panel flange and attach the Kest-Lock Connection on it.
Kest-Lock Pipe Inline	When you want to have a Kest-Lock connection on a pipe you weld on the pipe inline flange and attach the Kest-Lock Connection on it.
Kest-Lock Pipe Inline Double	When you want to have two Kest-Lock connection on a pipe you weld on the pipe inline double flange and attach the Kest-Lock Connection on it.
Blind TC with knob	When you want to have a blind cap on your Kest-Lock. It is equipped with a small knob to make it easy to remove.



YOU HAVE TO USE A STANDARD GASKET ISO 2852 type B









DON'T PRESSURIZE THE SYSTEM UNTIL YOU HAVE TIGHTEN THE KEST-LOCK.

General information

How to combine the parts



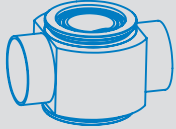

Choose your pipe standard and look up the corresponding flange. The TC Size on the flange will determine the size on the Kest-Lock ring that shall have the same corresponding TC size.



		
Kest-Lock Tank Flange	Kest-Lock Pipe Adapter Flange	Kest-Lock Pipe Inline
		
Kest-Lock Pipe Flange	Kest-Lock Pipe Panel Flange	Kest-Lock Pipe Inline Double

Kest-Lock Snap Ring + Kest-Lock Tank Flange, Kest-Lock Pipe Flange, Kest-Lock Pipe Adapter Flange, Kest-Lock Pipe Panel Flange, Kest-Lock Pipe Inline or Kest-Lock Pipe Inline Double

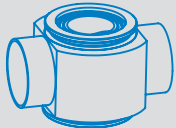

		
Kest-Lock Tank Flange	Kest-Lock Pipe Adapter Flange	Kest-Lock Pipe Inline
		
Kest-Lock Pipe Flange	Kest-Lock Pipe Panel Flange	Kest-Lock Pipe Inline Double

Kest-Lock Basic Ring + Kest-Lock Tank Flange, Kest-Lock Pipe Flange, Kest-Lock Pipe Adapter Flange, Kest-Lock Pipe Panel Flange, Kest-Lock Pipe Inline or Kest-Lock Pipe Inline Double

Gaskets

KEST Technology AB recommends to use a gasket like Rubber Fab's Tuf-Flex® (layer of PTFE grafted to an EPDM inner core). The low friction between the PTFE and the stainless steel secure that the gasket easily slides into the groove of the Tri Clamp for correct alignment. Tuf-Flex® is specifically designed to meet critical requirements in pharmaceutical, biotechnology, ultrapure water, WFI. Find out more at <https://www.rubberfab.com>

Kest-Lock Snap and Basic

SPECIFICATIONS

Material Grade	EN 1.4404	ASTM 316L or ASME 316L
Material requirement	EN 10 272/10028-7	A479/A240 or SA479/SA240
Documentation	Heat Certificate 3.1 acc. to EN 10 204	
Surface finish	Ra ≤ [1.6 µm] [63 µin] (Snap version, outer surface polished. Basic version, outer surface grinded)	
Design Temperature	[-80°C to 200°C] [112°F to 392°F]	
Design Pressure	[-1 bar(g) to + 10 bar(g)] [-14.5 psi to 145 psi]	
Marking	Marked with brand, material grade, product code and heat number	
Packing	Sealed in vacuum plastic bag, labelled with art.number and packed in a box	
Gaskets	The Kest-Lock is designed for use of standard gaskets acc. to ISO 2852 type B	
Standard	The Kest-Lock is designed for clamp couplings acc ISO 2852, ASME BPE, DIN 32 676	
Quality Assurance	Each product is controlled and tested acc. to Kest Technology quality assurance system	

Kest-Lock Snap Ring



Kest-Lock Basic Ring

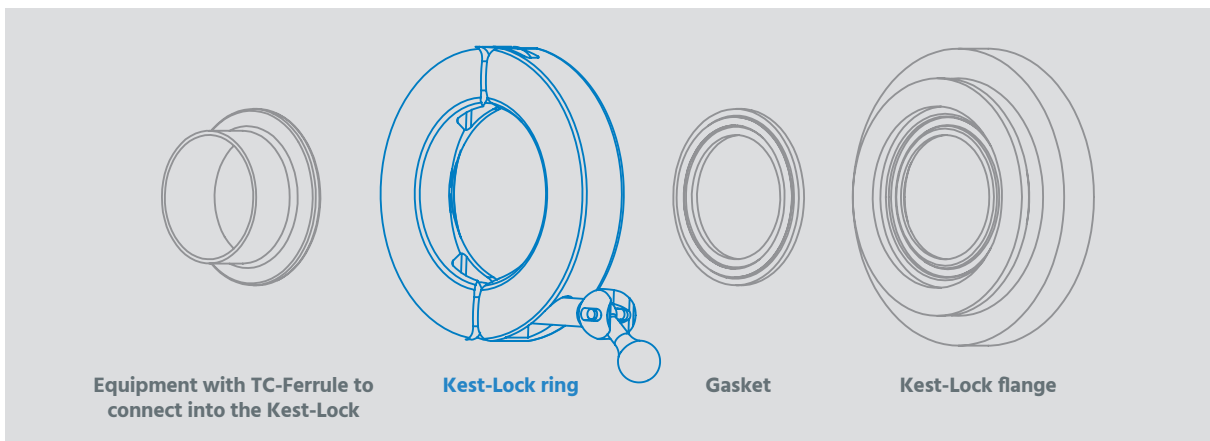

Kest-Lock Snap Ring

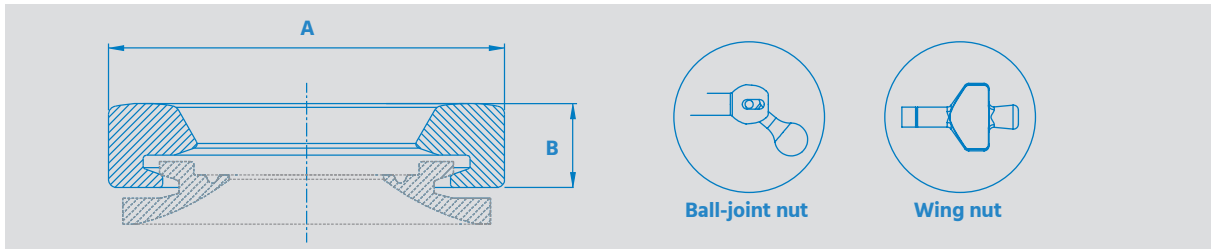

REF. NO	SIZE TC Size [ASTM Tube size]	PRODUCT CODE	TC mm [in]	A mm [in]	B mm [in]
Kest-Lock Snap ring with ball-joint nut					
100012	TC 25 [1/2" & 3/4"]	KLS-TC25-BJN	25 [0.984]	59 [2.323]	20.5 [0.807]
100013	TC 34 [-]	KLS-TC34-BJN	34 [1.339]	70 [2.756]	20.5 [0.807]
100014	TC 50.5 [1" & 1 1/2"]	KLS-TC50-BJN	50.5 [1.988]	85 [3.346]	20.5 [0.807]
100015	TC 64 [2"]	KLS-TC64-BJN	64 [2.520]	99 [3.898]	20.5 [0.807]
100016	TC 77.5 [2 1/2"]	KLS-TC77-BJN	77.5 [3.051]	117 [4.606]	23.5 [0.925]
100017	TC 91 [3"]	KLS-TC91-BJN	91 [3.583]	126 [4.961]	23.5 [0.925]
100018	TC 106 [-]	KLS-TC106-BJN	106 [4.173]	146 [5.748]	23.5 [0.925]
100024	TC 119 [4"]	KLS-TC119-BJN	119 [4.685]	158.5 [6.240]	24.5 [0.965]
Kest-Lock Snap ring with wing nut					
100316	TC 25 [1/2" & 3/4"]	KLS-TC25-WN	25 [0.984]	59 [2.323]	20.5 [0.807]
101192	TC 34 [-]	KLS-TC34-WN	34 [1.339]	70 [2.756]	20.5 [0.807]
100297	TC 50.5 [1" & 1 1/2"]	KLS-TC50-WN	50.5 [1.988]	85 [3.346]	20.5 [0.807]
100323	TC 64 [2"]	KLS-TC64-WN	64 [2.520]	99 [3.898]	20.5 [0.807]

Kest-Lock Basic Ring

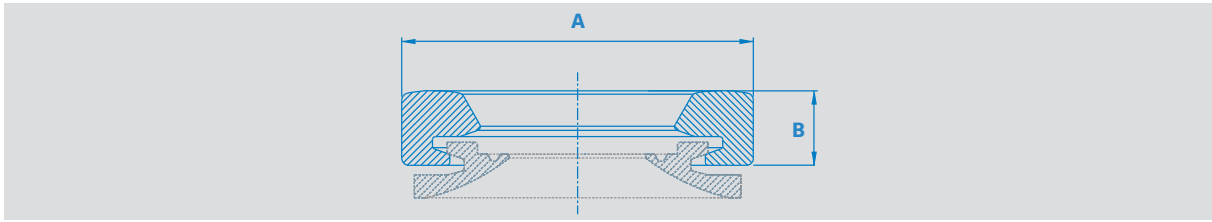

REF. NO	SIZE TC Size [ASTM Tube size]	PRODUCT CODE	TC mm [in]	A mm [in]	B mm [in]
100025	TC 25 [1/2" & 3/4"]	KLB-TC25-IHS	25 [0.984]	59 [2.323]	20.5 [0.807]
100026	TC 34 [-]	KLB-TC34-IHS	34 [1.339]	70 [2.756]	20.5 [0.807]
100027	TC 50.5 [1" & 1 1/2"]	KLB-TC50-IHS	50.5 [1.988]	85 [3.346]	20.5 [0.807]
100028	TC 64 [2"]	KLB-TC64-IHS	64 [2.520]	99 [3.898]	20.5 [0.807]
100029	TC 77.5 [2 1/2"]	KLB-TC77-IHS	77.5 [3.051]	117 [4.606]	23.5 [0.925]
100030	TC 91 [3"]	KLB-TC91-IHS	91 [3.583]	126 [4.961]	23.5 [0.925]
100031	TC 106 [-]	KLB-TC106-IHS	106 [4.173]	146 [5.748]	23.5 [0.925]
100032	TC 119 [4"]	KLB-TC119-IHS	119 [4.685]	158.5 [6.240]	24.5 [0.965]

Kest-Lock Tank Flange

SPECIFICATIONS

Material Grade	EN 1.4435	ASTM 316L or ASME 316L
Material requirement	EN 10 272/10028-7	A479/A240 or SA479/SA240
Documentation	Heat Certificate 3.1 acc. to EN 10 204	
Surface finish	Ra≤[0.5 μm] [20 μin] internal (polished)	Ra≤[1.6 μm] [63 μin] outer
Design Temperature	[-80°C to 200°C] [112°F to 392°F]	
Design Pressure	[-1 bar(g) to + 10 bar(g)] [-14.5 psi to 145 psi]	
Marking	Marked with material grade and heat number	
Packing	Sealed in vacuum plastic bag, labelled with art. number and packed in a box	
Gaskets	The Kest-Lock is designed for use of standard gaskets acc. to ISO 2852 type B	
Standards	The Kest-Lock is designed for clamp couplings acc ISO 2852, ASME BPE, DIN 32 676	
Quality Assurance	Each product is controlled and tested acc. to Kest Technology quality assurance system	

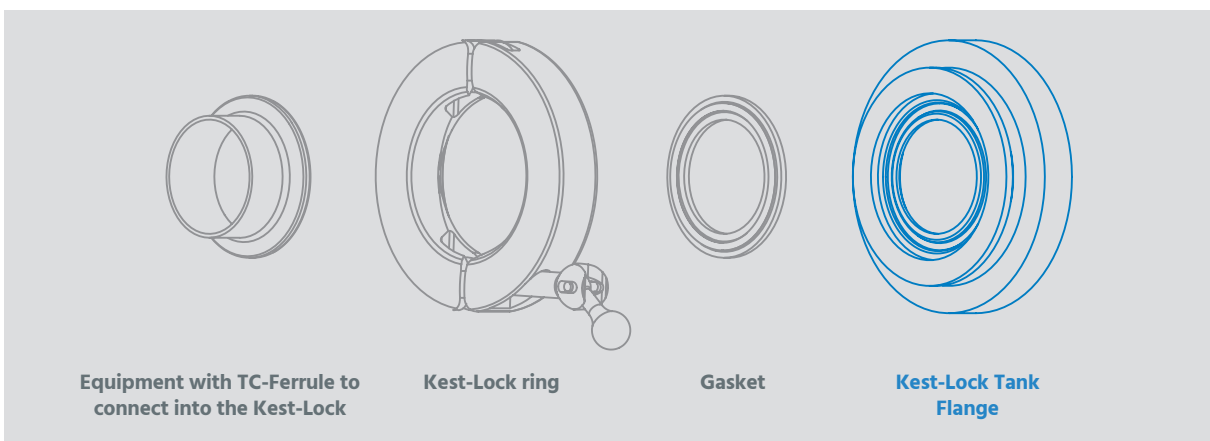
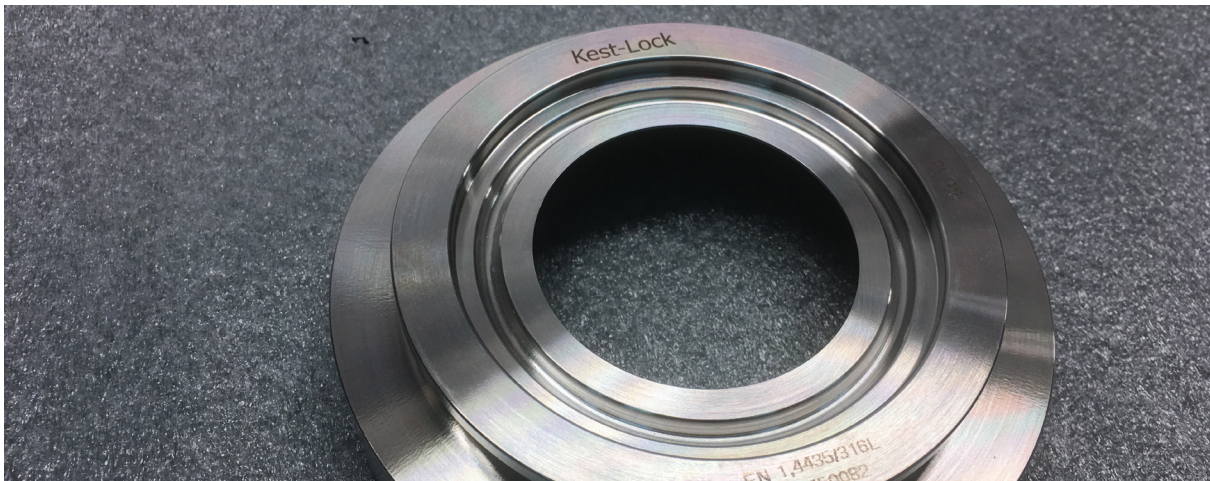

The Kest-Lock tank flange is available in five different heights to fit your tank geometry, from 6 mm to 51 mm.

H 6 mm / 0.236 in H 38 mm / 1.496 in
 H 12 mm / 0.472 in H 51 mm / 2.008 in
 H 25 mm / 0.984 in

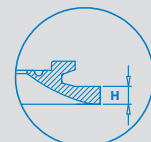

Kest-Lock Tank Flange

**ASTM
A 269/270**

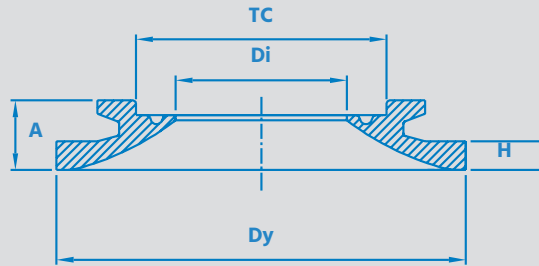

REF. NO	PRODUCT CODE	TC mm [in]	DY mm [in]	DI mm [in]	H mm [in]	A mm [in]
TC 1/2" (TC25) - For pipe ASTM 1/2" (12.7x1.65)						
100068	KLTF-TC25-ASTM0.5-55-6	25 [0.984]	55 [2.165]	9.4 [0.370]	6 [0.236]	14.5 [0.571]
100069	KLTF-TC25-ASTM0.5-55-12	25 [0.984]	55 [2.165]	9.4 [0.370]	12 [0.472]	20.5 [0.807]
100070	KLTF-TC25-ASTM0.5-55-25	25 [0.984]	55 [2.165]	9.4 [0.370]	25 [0.984]	33.5 [1.319]
100071	KLTF-TC25-ASTM0.5-55-38	25 [0.984]	55 [2.165]	9.4 [0.370]	38 [1.496]	46.5 [1.831]
100072	KLTF-TC25-ASTM0.5-55-51	25 [0.984]	55 [2.165]	9.4 [0.370]	51 [2.008]	59.5 [2.343]
TC 3/4" (TC25) - For pipe ASTM 3/4" (19.1x1.65)						
100073	KLTF-TC25-ASTM0.75-55-6	25 [0.984]	55 [2.165]	15.8 [0.622]	6 [0.236]	14.5 [0.571]
100074	KLTF-TC25-ASTM0.75-55-12	25 [0.984]	55 [2.165]	15.8 [0.622]	12 [0.472]	20.5 [0.807]
100075	KLTF-TC25-ASTM0.75-55-25	25 [0.984]	55 [2.165]	15.8 [0.622]	25 [0.984]	33.5 [1.319]
100076	KLTF-TC25-ASTM0.75-55-38	25 [0.984]	55 [2.165]	15.8 [0.622]	38 [1.496]	46.5 [1.831]
100077	KLTF-TC25-ASTM0.75-55-51	25 [0.984]	55 [2.165]	15.8 [0.622]	51 [2.008]	59.5 [2.343]
TC 1" (TC50.5) - For pipe ASTM 1" (25.4x1.65)						
100078	KLTF-TC50-ASTM1.0-85-6	50.5 [1.988]	85 [3.346]	22.1 [0.870]	6 [0.236]	14.5 [0.571]
100079	KLTF-TC50-ASTM1.0-85-12	50.5 [1.988]	85 [3.346]	22.1 [0.870]	12 [0.472]	20.5 [0.807]
100080	KLTF-TC50-ASTM1.0-85-25	50.5 [1.988]	85 [3.346]	22.1 [0.870]	25 [0.984]	33.5 [1.319]
100081	KLTF-TC50-ASTM1.0-85-38	50.5 [1.988]	85 [3.346]	22.1 [0.870]	38 [1.496]	46.5 [1.831]
100082	KLTF-TC50-ASTM1.0-85-51	50.5 [1.988]	85 [3.346]	22.1 [0.870]	51 [2.008]	59.5 [2.343]

Kest-Lock Tank Flange

**ASTM
A 269/270**

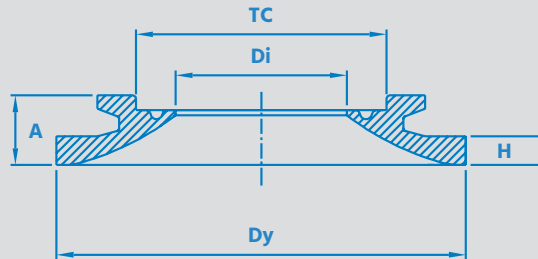

REF. NO	PRODUCT CODE	TC mm [in]	DY mm [in]	DI mm [in]	H mm [in]	A mm [in]
TC 1 1/2" (TC50.5) - For pipe ASTM 1 1/2" (38.1x1.65)						
100083	KLTF-TC50-ASTM1.5-85-6	50.5 [1.988]	85 [3.346]	34.8 [1.370]	6 [0.236]	14.5 [0.571]
100084	KLTF-TC50-ASTM1.5-85-12	50.5 [1.988]	85 [3.346]	34.8 [1.370]	12 [0.472]	20.5 [0.807]
100085	KLTF-TC50-ASTM1.5-85-25	50.5 [1.988]	85 [3.346]	34.8 [1.370]	25 [0.984]	33.5 [1.319]
100086	KLTF-TC50-ASTM1.5-85-38	50.5 [1.988]	85 [3.346]	34.8 [1.370]	38 [1.496]	46.5 [1.831]
100087	KLTF-TC50-ASTM1.5-85-51	50.5 [1.988]	85 [3.346]	34.8 [1.370]	51 [2.008]	59.5 [2.343]
TC 2" (TC64) - For pipe ASTM 2" (50.8x1.65)						
100088	KLTF-TC64-ASTM2.0-100-6	64 [2.520]	100 [3.937]	47.5 [1.870]	6 [0.236]	14.5 [0.571]
100089	KLTF-TC64-ASTM2.0-100-12	64 [2.520]	100 [3.937]	47.5 [1.870]	12 [0.472]	20.5 [0.807]
100090	KLTF-TC64-ASTM2.0-100-25	64 [2.520]	100 [3.937]	47.5 [1.870]	25 [0.984]	33.5 [1.319]
100091	KLTF-TC64-ASTM2.0-100-38	64 [2.520]	100 [3.937]	47.5 [1.870]	38 [1.496]	46.5 [1.831]
100092	KLTF-TC64-ASTM2.0-100-51	64 [2.520]	100 [3.937]	47.5 [1.870]	51 [2.008]	59.5 [2.343]
TC 2.5" (TC77.5) - For pipe ASTM 2.5" (63.5x1.65)						
100093	KLTF-TC77-ASTM2.5-112-6	77.5 [3.051]	112 [4.409]	60.2 [2.370]	6 [0.236]	14.5 [0.571]
100094	KLTF-TC77-ASTM2.5-112-12	77.5 [3.051]	112 [4.409]	60.2 [2.370]	12 [0.472]	20.5 [0.807]
100095	KLTF-TC77-ASTM2.5-112-25	77.5 [3.051]	112 [4.409]	60.2 [2.370]	25 [0.984]	33.5 [1.319]
100096	KLTF-TC77-ASTM2.5-112-38	77.5 [3.051]	112 [4.409]	60.2 [2.370]	38 [1.496]	46.5 [1.831]
100097	KLTF-TC77-ASTM2.5-112-51	77.5 [3.051]	112 [4.409]	60.2 [2.370]	51 [2.008]	59.5 [2.343]

Kest-Lock Tank Flange

ASTM
A 269/270

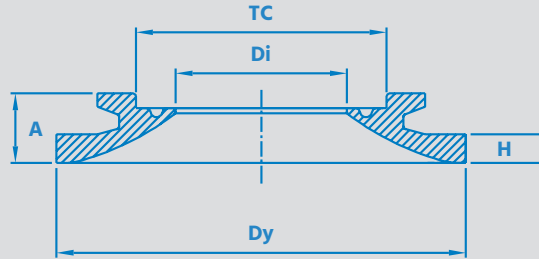

REF. NO	PRODUCT CODE	TC mm [in]	DY mm [in]	DI mm [in]	H mm [in]	A mm [in]
TC 3" (TC91) - For pipe ASTM 3" (76.2x1.65)						
100098	KLTF-TC91-ASTM3.0-131-6	91 [3.583]	131 [5.157]	72.9 [2.870]	6 [0.236]	14.5 [0.571]
100099	KLTF-TC91-ASTM3.0-131-12	91 [3.583]	131 [5.157]	72.9 [2.870]	12 [0.472]	20.5 [0.807]
100100	KLTF-TC91-ASTM3.0-131-25	91 [3.583]	131 [5.157]	72.9 [2.870]	25 [0.984]	33.5 [1.319]
100101	KLTF-TC91-ASTM3.0-131-38	91 [3.583]	131 [5.157]	72.9 [2.870]	38 [1.496]	46.5 [1.831]
100102	KLTF-TC91-ASTM3.0-131-51	91 [3.583]	131 [5.157]	72.9 [2.870]	51 [2.008]	59.5 [2.343]
TC 4"(TC119) - For pipe ASTM 4" (101.6x2.1)						
100637	KLTF-TC119-ASTM-4.0-159-6	119 [4.685]	159 [6.260]	97.4 [3.835]	6 [0.236]	14.5 [0.571]
100638	KLTF-TC119-ASTM-4.0-159-12	119 [4.685]	159 [6.260]	97.4 [3.835]	12 [0.472]	20.5 [0.807]
101621	KLTF-TC119-ASTM-4.0-159-25	119 [4.685]	159 [6.260]	97.4 [3.835]	25 [0.984]	33.5 [1.319]
101109	KLTF-TC119-ASTM-4.0-159-38	119 [4.685]	159 [6.260]	97.4 [3.835]	38 [1.496]	46.5 [1.831]
101622	KLTF-TC119-ASTM-4.0-159-51	119 [4.685]	159 [6.260]	97.4 [3.835]	51 [2.008]	59.5 [2.343]

Kest-Lock Tank Flange

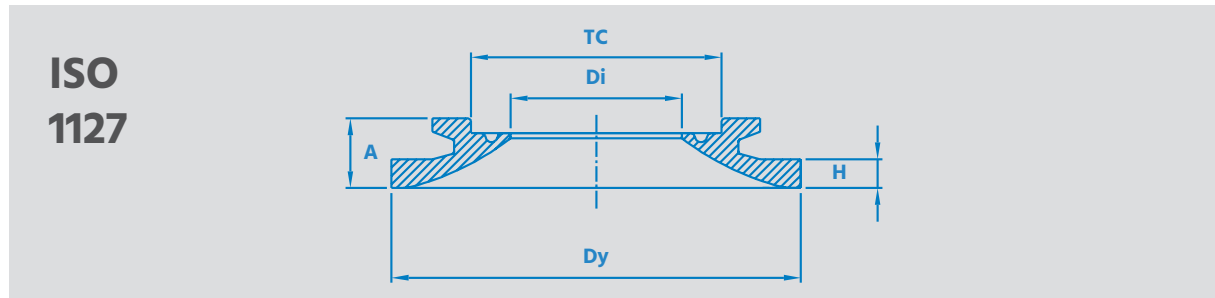

REF. NO	PRODUCT CODE	TC mm [in]	DY mm [in]	DI mm [in]	H mm [in]	A mm [in]
TC25 - For pipe ISO DN8 (13.5x1.6)						
100104	KLTF-TC25-ISO8-55-6	25 [0.984]	55 [2.165]	10.3 [0.406]	6 [0.236]	14.5 [0.571]
100105	KLTF-TC25-ISO8-55-12	25 [0.984]	55 [2.165]	10.3 [0.406]	12 [0.472]	20.5 [0.807]
100106	KLTF-TC25-ISO8-55-25	25 [0.984]	55 [2.165]	10.3 [0.406]	25 [0.984]	33.5 [1.319]
100107	KLTF-TC25-ISO8-55-38	25 [0.984]	55 [2.165]	10.3 [0.406]	38 [1.496]	46.5 [1.831]
100108	KLTF-TC25-ISO8-55-51	25 [0.984]	55 [2.165]	10.3 [0.406]	51 [2.008]	59.5 [2.343]
TC34 - For pipe ISO DN10 (17.2x1.6)						
100109	KLTF-TC34-ISO10-70-6	34 [1.339]	70 [2.756]	14 [0.551]	6 [0.236]	14.5 [0.571]
100110	KLTF-TC34-ISO10-70-12	34 [1.339]	70 [2.756]	14 [0.551]	12 [0.472]	20.5 [0.807]
100111	KLTF-TC34-ISO10-70-25	34 [1.339]	70 [2.756]	14 [0.551]	25 [0.984]	33.5 [1.319]
100112	KLTF-TC34-ISO10-70-38	34 [1.339]	70 [2.756]	14 [0.551]	38 [1.496]	46.5 [1.831]
100113	KLTF-TC34-ISO10-70-51	34 [1.339]	70 [2.756]	14 [0.551]	51 [2.008]	59.5 [2.343]
TC34 - For pipe ISO DN15 (21.3x1.6)						
100114	KLTF-TC34-ISO15-70-6	34 [1.339]	70 [2.756]	18.1 [0.713]	6 [0.236]	14.5 [0.571]
100115	KLTF-TC34-ISO15-70-12	34 [1.339]	70 [2.756]	18.1 [0.713]	12 [0.472]	20.5 [0.807]
100116	KLTF-TC34-ISO15-70-25	34 [1.339]	70 [2.756]	18.1 [0.713]	25 [0.984]	33.5 [1.319]
100117	KLTF-TC34-ISO15-70-38	34 [1.339]	70 [2.756]	18.1 [0.713]	38 [1.496]	46.5 [1.831]
100118	KLTF-TC34-ISO15-70-51	34 [1.339]	70 [2.756]	18.1 [0.713]	51 [2.008]	59.5 [2.343]

Kest-Lock Tank Flange

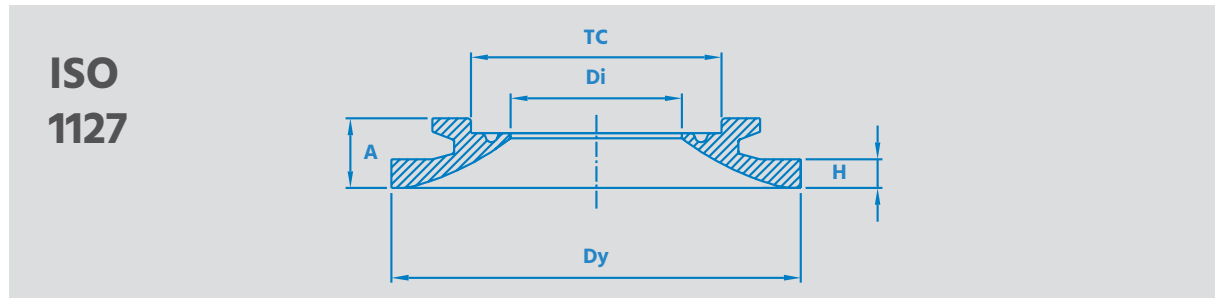

REF. NO	PRODUCT CODE	TC mm [in]	DY mm [in]	DI mm [in]	H mm [in]	A mm [in]
TC50.5 - For pipe ISO DN20 (26.9x1.6)						
100119	KLTF-TC50-ISO20-85-6	50.5 [1.988]	85 [3.346]	23.7 [0.933]	6 [0.236]	14.5 [0.571]
100120	KLTF-TC50-ISO20-85-12	50.5 [1.988]	85 [3.346]	23.7 [0.933]	12 [0.472]	20.5 [0.807]
100121	KLTF-TC50-ISO20-85-25	50.5 [1.988]	85 [3.346]	23.7 [0.933]	25 [0.984]	33.5 [1.319]
100122	KLTF-TC50-ISO20-85-38	50.5 [1.988]	85 [3.346]	23.7 [0.933]	38 [1.496]	46.5 [1.831]
100123	KLTF-TC50-ISO20-85-51	50.5 [1.988]	85 [3.346]	23.7 [0.933]	51 [2.008]	59.5 [2.343]
TC50.5 - For pipe ISO DN25 (33.7x2.0)						
100124	KLTF-TC50-ISO25-85-6	50.5 [1.988]	85 [3.346]	29.7 [1.169]	6 [0.236]	14.5 [0.571]
100125	KLTF-TC50-ISO25-85-12	50.5 [1.988]	85 [3.346]	29.7 [1.169]	12 [0.472]	20.5 [0.807]
100126	KLTF-TC50-ISO25-85-25	50.5 [1.988]	85 [3.346]	29.7 [1.169]	25 [0.984]	33.5 [1.319]
100127	KLTF-TC50-ISO25-85-38	50.5 [1.988]	85 [3.346]	29.7 [1.169]	38 [1.496]	46.5 [1.831]
100128	KLTF-TC50-ISO25-85-51	50.5 [1.988]	85 [3.346]	29.7 [1.169]	51 [2.008]	59.5 [2.343]
TC64 - For pipe ISO DN32 (42.4x2.0)						
100129	KLTF-TC64-ISO32-100-6	64 [2.520]	100 [3.937]	38.4 [1.512]	6 [0.236]	14.5 [0.571]
100130	KLTF-TC64-ISO32-100-12	64 [2.520]	100 [3.937]	38.4 [1.512]	12 [0.472]	20.5 [0.807]
100131	KLTF-TC64-ISO32-100-25	64 [2.520]	100 [3.937]	38.4 [1.512]	25 [0.984]	33.5 [1.319]
100132	KLTF-TC64-ISO32-100-38	64 [2.520]	100 [3.937]	38.4 [1.512]	38 [1.496]	46.5 [1.831]
100133	KLTF-TC64-ISO32-100-51	64 [2.520]	100 [3.937]	38.4 [1.512]	51 [2.008]	59.5 [2.343]

Kest-Lock Tank Flange

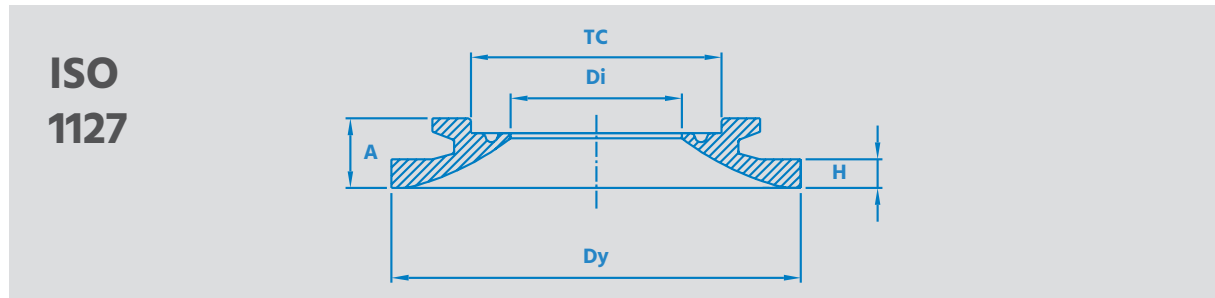

REF. NO	PRODUCT CODE	TC mm [in]	DY mm [in]	DI mm [in]	H mm [in]	A mm [in]
TC64 - For pipe ISO DN40 (48.3x2.0)						
100134	KLTF-TC64-ISO40-100-6	64 [2.520]	100 [3.937]	44.3 [1.744]	6 [0.236]	14.5 [0.571]
100135	KLTF-TC64-ISO40-100-12	64 [2.520]	100 [3.937]	44.3 [1.744]	12 [0.472]	20.5 [0.807]
100136	KLTF-TC64-ISO40-100-25	64 [2.520]	100 [3.937]	44.3 [1.744]	25 [0.984]	33.5 [1.319]
100137	KLTF-TC64-ISO40-100-38	64 [2.520]	100 [3.937]	44.3 [1.744]	38 [1.496]	46.5 [1.831]
100138	KLTF-TC64-ISO40-100-51	64 [2.520]	100 [3.937]	44.3 [1.744]	51 [2.008]	59.5 [2.343]
TC77.5 - For pipe ISO DN50 (60.3x2.0)						
100139	KLTF-TC77-ISO50-112-6	77.5 [3.051]	112 [4.409]	56.3 [2.216]	6 [0.236]	14.5 [0.571]
100140	KLTF-TC77-ISO50-112-12	77.5 [3.051]	112 [4.409]	56.3 [2.216]	12 [0.472]	20.5 [0.807]
100141	KLTF-TC77-ISO50-112-25	77.5 [3.051]	112 [4.409]	56.3 [2.216]	25 [0.984]	33.5 [1.319]
100142	KLTF-TC77-ISO50-112-38	77.5 [3.051]	112 [4.409]	56.3 [2.216]	38 [1.496]	46.5 [1.831]
100143	KLTF-TC77-ISO50-112-51	77.5 [3.051]	112 [4.409]	56.3 [2.216]	51 [2.008]	59.5 [2.343]
TC91, For pipe ISO DN65 (76.1x2.3)						
100144	KLTF-TC91-ISO65-131-6	91 [3.583]	131 [5.157]	71.5 [2.815]	6 [0.236]	14.5 [0.571]
100145	KLTF-TC91-ISO65-131-12	91 [3.583]	131 [5.157]	71.5 [2.815]	12 [0.472]	20.5 [0.807]
100146	KLTF-TC91-ISO65-131-25	91 [3.583]	131 [5.157]	71.5 [2.815]	25 [0.984]	33.5 [1.319]
100147	KLTF-TC91-ISO65-131-38	91 [3.583]	131 [5.157]	71.5 [2.815]	38 [1.496]	46.5 [1.831]
100148	KLTF-TC91-ISO65-131-51	91 [3.583]	131 [5.157]	71.5 [2.815]	51 [2.008]	59.5 [2.343]

Kest-Lock Tank Flange

ISO
1127

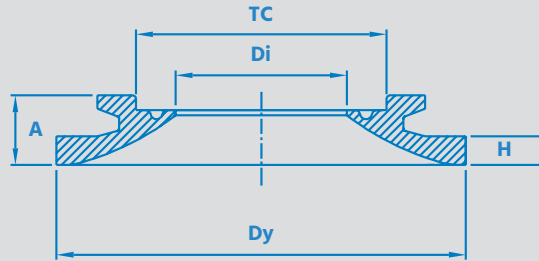

REF. NO	PRODUCT CODE	TC mm [in]	DY mm [in]	DI mm [in]	H mm [in]	A mm [in]
TC106 - For pipe ISO DN80 (88.9x2.3)						
100279	KLTF-TC106-ISO80-146-6	106 [4.173]	146 [5.748]	84.3 [3.319]	6 [0.236]	14.5 [0.571]
100280	KLTF-TC106-ISO80-146-12	106 [4.173]	146 [5.748]	84.3 [3.319]	12 [0.472]	20.5 [0.807]
100247	KLTF-TC106-ISO80-146-25	106 [4.173]	146 [5.748]	84.3 [3.319]	25 [0.984]	33.5 [1.319]
100250	KLTF-TC106-ISO80-146-38	106 [4.173]	146 [5.748]	84.3 [3.319]	38 [1.496]	46.5 [1.831]
101623	KLTF-TC106-ISO80-146-51	106 [4.173]	146 [5.748]	84.3 [3.319]	51 [2.008]	59.5 [2.343]

Kest-Lock Tank Flange

EN 10357-A
(DIN 11850-R2)

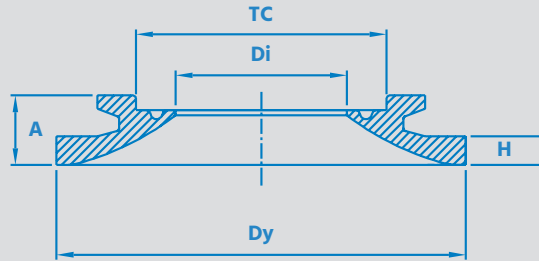

REF. NO	PRODUCT CODE	TC mm [in]	DY mm [in]	DI mm [in]	H mm [in]	A mm [in]
TC34 - For pipe EN DN10 (13 x 1.5)						
101687	KLTF-TC34-EN10-70-6	34 [1.339]	70 [2.756]	10 [0.394]	6 [0.236]	14.5 [0.571]
101688	KLTF-TC34-EN10-70-12	34 [1.339]	70 [2.756]	10 [0.394]	12 [0.472]	20.5 [0.807]
101689	KLTF-TC34-EN10-70-25	34 [1.339]	70 [2.756]	10 [0.394]	25 [0.984]	33.5 [1.319]
101690	KLTF-TC34-EN10-70-38	34 [1.339]	70 [2.756]	10 [0.394]	38 [1.496]	46.5 [1.831]
101691	KLTF-TC34-EN10-70-51	34 [1.339]	70 [2.756]	10 [0.394]	51 [2.008]	59.5 [2.343]
TC34 - For pipe EN DN15 (19 x 1.5)						
101692	KLTF-TC34-EN15-70-6	34 [1.339]	70 [2.756]	16 [0.630]	6 [0.236]	14.5 [0.571]
101693	KLTF-TC34-EN15-70-12	34 [1.339]	70 [2.756]	16 [0.630]	12 [0.472]	20.5 [0.807]
101694	KLTF-TC34-EN15-70-25	34 [1.339]	70 [2.756]	16 [0.630]	25 [0.984]	33.5 [1.319]
101695	KLTF-TC34-EN15-70-38	34 [1.339]	70 [2.756]	16 [0.630]	38 [1.496]	46.5 [1.831]
101696	KLTF-TC34-EN15-70-51	34 [1.339]	70 [2.756]	16 [0.630]	51 [2.008]	59.5 [2.343]
TC34 - For pipe EN DN20 (23 x 1.5)						
101683	KLTF-TC34-EN20-70-6	34 [1.339]	70 [2.756]	20 [0.787]	6 [0.236]	14.5 [0.571]
101684	KLTF-TC34-EN20-70-12	34 [1.339]	70 [2.756]	20 [0.787]	12 [0.472]	20.5 [0.807]
101685	KLTF-TC34-EN20-70-25	34 [1.339]	70 [2.756]	20 [0.787]	25 [0.984]	33.5 [1.319]
101141	KLTF-TC34-EN20-70-38	34 [1.339]	70 [2.756]	20 [0.787]	38 [1.496]	46.5 [1.831]
101686	KLTF-TC34-EN20-70-51	34 [1.339]	70 [2.756]	20 [0.787]	51 [2.008]	59.5 [2.343]

Kest-Lock Tank Flange

EN 10357-A
(DIN 11850-R2)

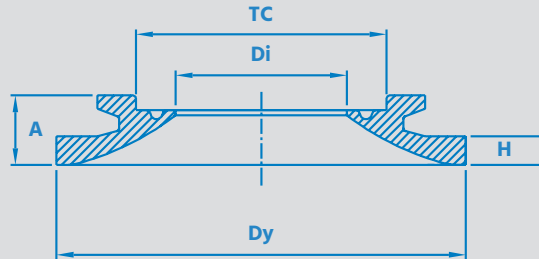

REF. NO	PRODUCT CODE	TC mm [in]	DY mm [in]	DI mm [in]	H mm [in]	A mm [in]
TC50.5 - For pipe EN DN25 (29 x 1.5)						
101274	KLTF-TC50-EN25-85-6	50.5 [1.988]	85 [3.346]	26 [1.024]	6 [0.236]	14.5 [0.571]
101680	KLTF-TC50-EN25-85-12	50.5 [1.988]	85 [3.346]	26 [1.024]	12 [0.472]	20.5 [0.807]
101681	KLTF-TC50-EN25-85-25	50.5 [1.988]	85 [3.346]	26 [1.024]	25 [0.984]	33.5 [1.319]
101142	KLTF-TC50-EN25-85-38	50.5 [1.988]	85 [3.346]	26 [1.024]	38 [1.496]	46.5 [1.831]
101682	KLTF-TC50-EN25-85-51	50.5 [1.988]	85 [3.346]	26 [1.024]	51 [2.008]	59.5 [2.343]
TC50.5 - For pipe EN DN32 (35 x 1.5)						
101677	KLTF-TC50-EN32-85-6	50.5 [1.988]	85 [3.346]	32 [1.260]	6 [0.236]	14.5 [0.571]
101678	KLTF-TC50-EN32-85-12	50.5 [1.988]	85 [3.346]	32 [1.260]	12 [0.472]	20.5 [0.807]
101143	KLTF-TC50-EN32-85-25	50.5 [1.988]	85 [3.346]	32 [1.260]	25 [0.984]	33.5 [1.319]
101679	KLTF-TC50-EN32-85-38	50.5 [1.988]	85 [3.346]	32 [1.260]	38 [1.496]	46.5 [1.831]
101457	KLTF-TC50-EN32-85-51	50.5 [1.988]	85 [3.346]	32 [1.260]	51 [2.008]	59.5 [2.343]
TC50.5 - For pipe EN DN40 (41 x 1.5)						
101673	KLTF-TC50-EN40-85-6	50.5 [1.988]	85 [3.346]	38 [1.496]	6 [0.236]	14.5 [0.571]
101144	KLTF-TC50-EN40-85-12	50.5 [1.988]	85 [3.346]	38 [1.496]	12 [0.472]	20.5 [0.807]
101624	KLTF-TC50-EN40-85-25	50.5 [1.988]	85 [3.346]	38 [1.496]	25 [0.984]	33.5 [1.319]
101675	KLTF-TC50-EN40-85-38	50.5 [1.988]	85 [3.346]	38 [1.496]	38 [1.496]	46.5 [1.831]
101676	KLTF-TC50-EN40-85-51	50.5 [1.988]	85 [3.346]	38 [1.496]	51 [2.008]	59.5 [2.343]

Kest-Lock Tank Flange

EN 10357-A
(DIN 11850-R2)

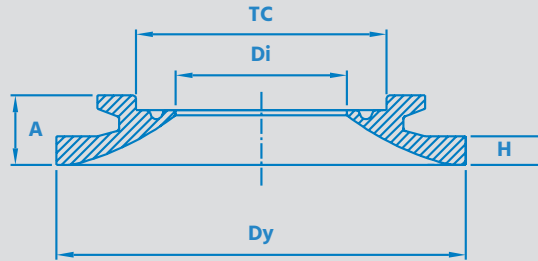

REF. NO	PRODUCT CODE	TC mm [in]	DY mm [in]	DI mm [in]	H mm [in]	A mm [in]
TC64 - For pipe EN DN50 (53 x 1.5)						
101665	KLTF-TC64-EN50-100-6	64 [2.520]	100 [3.937]	50 [1.969]	6 [0.236]	14.5 [0.571]
101145	KLTF-TC64-EN50-100-12	64 [2.520]	100 [3.937]	50 [1.969]	12 [0.472]	20.5 [0.807]
101666	KLTF-TC64-EN50-100-25	64 [2.520]	100 [3.937]	50 [1.969]	25 [0.984]	33.5 [1.319]
101667	KLTF-TC64-EN50-100-38	64 [2.520]	100 [3.937]	50 [1.969]	38 [1.496]	46.5 [1.831]
101146	KLTF-TC64-EN50-100-51	64 [2.520]	100 [3.937]	50 [1.969]	51 [2.008]	59.5 [2.343]
TC91 - For pipe EN DN65 (70 x 2.0)						
101668	KLTF-TC91-EN65-131-6	91 [3.583]	131 [5.157]	66 [2.598]	6 [0.236]	14.5 [0.571]
101669	KLTF-TC91-EN65-131-12	91 [3.583]	131 [5.157]	66 [2.598]	12 [0.472]	20.5 [0.807]
101670	KLTF-TC91-EN65-131-25	91 [3.583]	131 [5.157]	66 [2.598]	25 [0.984]	33.5 [1.319]
101671	KLTF-TC91-EN65-131-38	91 [3.583]	131 [5.157]	66 [2.598]	38 [1.496]	46.5 [1.831]
101672	KLTF-TC91-EN65-131-51	91 [3.583]	131 [5.157]	66 [2.598]	51 [2.008]	59.5 [2.343]
TC106 - For pipe EN DN80 (85 x 2.0)						
101432	KLTF-TC106-EN80-146-6	106 [4.173]	146 [5.748]	81 [3.189]	6 [0.236]	14.5 [0.571]
101433	KLTF-TC106-EN80-146-12	106 [4.173]	146 [5.748]	81 [3.189]	12 [0.472]	20.5 [0.807]
101434	KLTF-TC106-EN80-146-25	106 [4.173]	146 [5.748]	81 [3.189]	25 [0.984]	33.5 [1.319]
101663	KLTF-TC106-EN80-146-38	106 [4.173]	146 [5.748]	81 [3.189]	38 [1.496]	46.5 [1.831]
101664	KLTF-TC106-EN80-146-51	106 [4.173]	146 [5.748]	81 [3.189]	51 [2.008]	59.5 [2.343]

Kest-Lock Tank Flange

**SMS
3008**

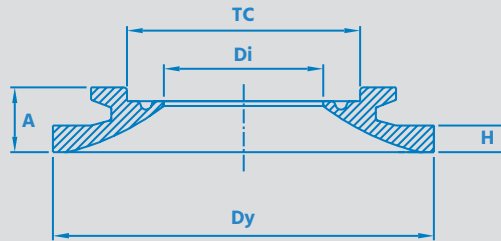

REF. NO	PRODUCT CODE	TC mm [in]	DY mm [in]	DI mm [in]	H mm [in]	A mm [in]
TC25 - For pipe SMS 12x1.0						
100033	KLTF-TC25-SMS12-55-6	25 [0.984]	55 [2.165]	10 [0.394]	6 [0.236]	14.5 [0.571]
100034	KLTF-TC25-SMS12-55-12	25 [0.984]	55 [2.165]	10 [0.394]	12 [0.472]	20.5 [0.807]
100035	KLTF-TC25-SMS12-55-25	25 [0.984]	55 [2.165]	10 [0.394]	25 [0.984]	33.5 [1.319]
100036	KLTF-TC25-SMS12-55-38	25 [0.984]	55 [2.165]	10 [0.394]	38 [1.496]	46.5 [1.831]
100037	KLTF-TC25-SMS12-55-51	25 [0.984]	55 [2.165]	10 [0.394]	51 [2.008]	59.5 [2.343]
TC25 - For pipe SMS 18x1.5						
100038	KLTF-TC25-SMS18-55-6	25 [0.984]	55 [2.165]	15 [0.591]	6 [0.236]	14.5 [0.571]
100039	KLTF-TC25-SMS18-55-12	25 [0.984]	55 [2.165]	15 [0.591]	12 [0.472]	20.5 [0.807]
100040	KLTF-TC25-SMS18-55-25	25 [0.984]	55 [2.165]	15 [0.591]	25 [0.984]	33.5 [1.319]
100041	KLTF-TC25-SMS18-55-38	25 [0.984]	55 [2.165]	15 [0.591]	38 [1.496]	46.5 [1.831]
100042	KLTF-TC25-SMS18-55-51	25 [0.984]	55 [2.165]	15 [0.591]	51 [2.008]	59.5 [2.343]
TC50.5 - For pipe SMS 25x1.2						
100043	KLTF-TC50-SMS25-85-6	50.5 [1.988]	85 [3.346]	22.6 [0.890]	6 [0.236]	14.5 [0.571]
100044	KLTF-TC50-SMS25-85-12	50.5 [1.988]	85 [3.346]	22.6 [0.890]	12 [0.472]	20.5 [0.807]
100045	KLTF-TC50-SMS25-85-25	50.5 [1.988]	85 [3.346]	22.6 [0.890]	25 [0.984]	33.5 [1.319]
100046	KLTF-TC50-SMS25-85-38	50.5 [1.988]	85 [3.346]	22.6 [0.890]	38 [1.496]	46.5 [1.831]
100047	KLTF-TC50-SMS25-85-51	50.5 [1.988]	85 [3.346]	22.6 [0.890]	51 [2.008]	59.5 [2.343]

Kest-Lock Tank Flange

**SMS
3008**

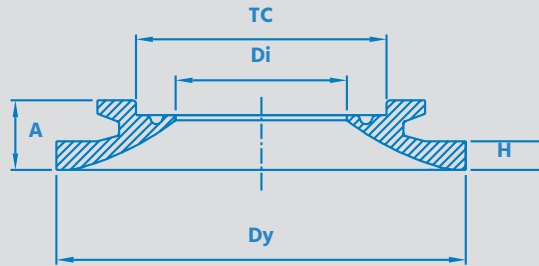

REF. NO	PRODUCT CODE	TC mm [in]	DY mm [in]	DI mm [in]	H mm [in]	A mm [in]
TC50.5 - For pipe SMS 38x1.2						
100048	KLTF-TC50-SMS38-85-6	50.5 [1.988]	85 [3.346]	35.6 [1.402]	6 [0.236]	14.5 [0.571]
100049	KLTF-TC50-SMS38-85-12	50.5 [1.988]	85 [3.346]	35.6 [1.402]	12 [0.472]	20.5 [0.807]
100050	KLTF-TC50-SMS38-85-25	50.5 [1.988]	85 [3.346]	35.6 [1.402]	25 [0.984]	33.5 [1.319]
100051	KLTF-TC50-SMS38-85-38	50.5 [1.988]	85 [3.346]	35.6 [1.402]	38 [1.496]	46.5 [1.831]
100052	KLTF-TC50-SMS38-85-51	50.5 [1.988]	85 [3.346]	35.6 [1.402]	51 [2.008]	59.5 [2.343]
TC64 - For pipe SMS 51x1.2						
100053	KLTF-TC64-SMS51-100-6	64 [2.520]	100 [3.937]	48.6 [1.913]	6 [0.236]	14.5 [0.571]
100054	KLTF-TC64-SMS51-100-12	64 [2.520]	100 [3.937]	48.6 [1.913]	12 [0.472]	20.5 [0.807]
100055	KLTF-TC64-SMS51-100-25	64 [2.520]	100 [3.937]	48.6 [1.913]	25 [0.984]	33.5 [1.319]
100056	KLTF-TC64-SMS51-100-38	64 [2.520]	100 [3.937]	48.6 [1.913]	38 [1.496]	46.5 [1.831]
100057	KLTF-TC64-SMS51-100-51	64 [2.520]	100 [3.937]	48.6 [1.913]	51 [2.008]	59.5 [2.343]
TC77.5 - For pipe SMS 63.5x1.6						
100058	KLTF-TC77-SMS63-112-6	77.5 [3.051]	112 [4.409]	60.3 [2.374]	6 [0.236]	14.5 [0.571]
100059	KLTF-TC77-SMS63-112-12	77.5 [3.051]	112 [4.409]	60.3 [2.374]	12 [0.472]	20.5 [0.807]
100060	KLTF-TC77-SMS63-112-25	77.5 [3.051]	112 [4.409]	60.3 [2.374]	25 [0.984]	33.5 [1.319]
100061	KLTF-TC77-SMS63-112-38	77.5 [3.051]	112 [4.409]	60.3 [2.374]	38 [1.496]	46.5 [1.831]
100062	KLTF-TC77-SMS63-112-51	77.5 [3.051]	112 [4.409]	60.3 [2.374]	51 [2.008]	59.5 [2.343]

Kest-Lock Tank Flange

**SMS
3008**

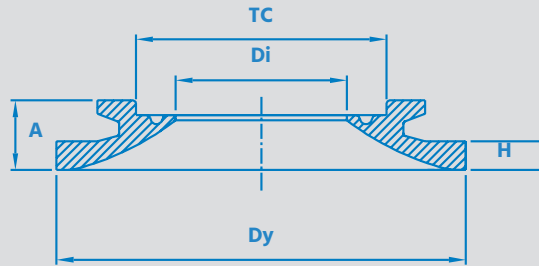

REF. NO	PRODUCT CODE	TC mm [in]	DY mm [in]	DI mm [in]	H mm [in]	A mm [in]
TC91 - For pipe SMS 76.1x1.6						
100063	KLTF-TC91-SMS76-131-6	91 [3.583]	131 [5.157]	72.9 [2.870]	6 [0.236]	14.5 [0.571]
100064	KLTF-TC91-SMS76-131-12	91 [3.583]	131 [5.157]	72.9 [2.870]	12 [0.472]	20.5 [0.807]
100065	KLTF-TC91-SMS76-131-25	91 [3.583]	131 [5.157]	72.9 [2.870]	25 [0.984]	33.5 [1.319]
100066	KLTF-TC91-SMS76-131-38	91 [3.583]	131 [5.157]	72.9 [2.870]	38 [1.496]	46.5 [1.831]
100067	KLTF-TC91-SMS76-131-51	91 [3.583]	131 [5.157]	72.9 [2.870]	51 [2.008]	59.5 [2.343]

Kest-Lock Tank Flange

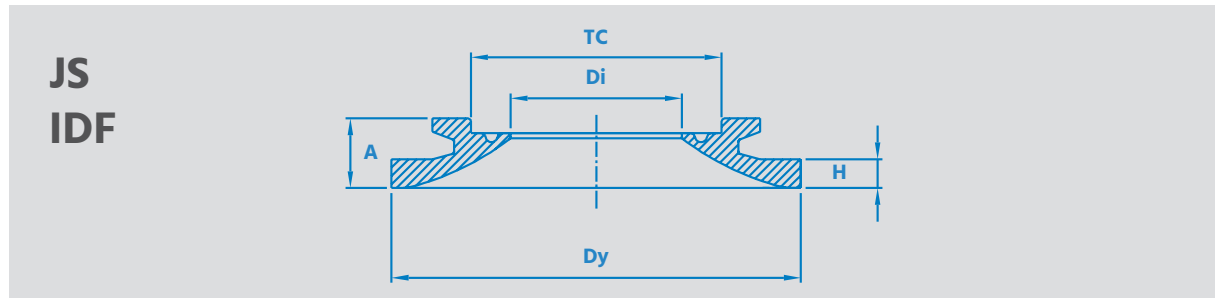

REF. NO	PRODUCT CODE	TC mm [in]	DY mm [in]	DI mm [in]	H mm [in]	A mm [in]
TC50 - For pipe JS1.0 (25.4x1.2)						
100287	KLTF-TC50-JS1.0S-85-6	50.5 [1.988]	85 [3.346]	23 [0.906]	6 [0.236]	14.5 [0.571]
100825	KLTF-TC50-JS1.0S-85-12	50.5 [1.988]	85 [3.346]	23 [0.906]	12 [0.472]	20.5 [0.807]
101697	KLTF-TC50-JS1.0S-85-25	50.5 [1.988]	85 [3.346]	23 [0.906]	25 [0.984]	33.5 [1.319]
101698	KLTF-TC50-JS1.0S-85-38	50.5 [1.988]	85 [3.346]	23 [0.906]	38 [1.496]	46.5 [1.831]
101699	KLTF-TC50-JS1.0S-85-51	50.5 [1.988]	85 [3.346]	23 [0.906]	51 [2.008]	59.5 [2.343]
TC50 - For pipe JS1.25 (31.8x1.2)						
100288	KLTF-TC50-JS1.25S-85-6	50.5 [1.988]	85 [3.346]	29.4 [1.157]	6 [0.236]	14.5 [0.571]
101198	KLTF-TC50-JS1.25S-85-12	50.5 [1.988]	85 [3.346]	29.4 [1.157]	12 [0.472]	20.5 [0.807]
101700	KLTF-TC50-JS1.25S-85-25	50.5 [1.988]	85 [3.346]	29.4 [1.157]	25 [0.984]	33.5 [1.319]
101701	KLTF-TC50-JS1.25S-85-38	50.5 [1.988]	85 [3.346]	29.4 [1.157]	38 [1.496]	46.5 [1.831]
101702	KLTF-TC50-JS1.25S-85-51	50.5 [1.988]	85 [3.346]	29.4 [1.157]	51 [2.008]	59.5 [2.343]
TC50 - For pipe JS1.5 (38.1x1.2)						
100339	KLTF-TC50-JS1.5S-85-6	50.5 [1.988]	85 [3.346]	35.7 [1.406]	6 [0.236]	14.5 [0.571]
101197	KLTF-TC50-JS1.5S-85-12	50.5 [1.988]	85 [3.346]	35.7 [1.406]	12 [0.472]	20.5 [0.807]
101415	KLTF-TC50-JS1.5S-85-25	50.5 [1.988]	85 [3.346]	35.7 [1.406]	25 [0.984]	33.5 [1.319]
101703	KLTF-TC50-JS1.5S-85-38	50.5 [1.988]	85 [3.346]	35.7 [1.406]	38 [1.496]	46.5 [1.831]
101704	KLTF-TC50-JS1.5S-85-51	50.5 [1.988]	85 [3.346]	35.7 [1.406]	51 [2.008]	59.5 [2.343]

Kest-Lock Tank Flange

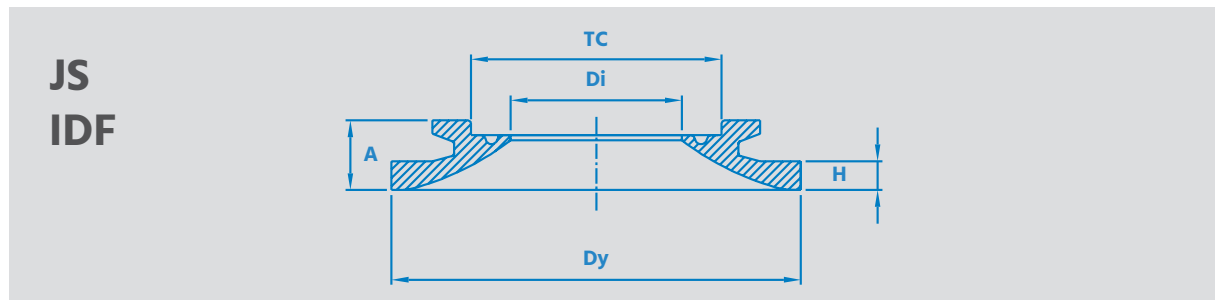

REF. NO	PRODUCT CODE	TC mm [in]	DY mm [in]	DI mm [in]	H mm [in]	A mm [in]
TC64 - For pipe JS2.0 (50.8x1.5)						
100289	KLTF-TC64-JS2.0S-100-6	64 [2.520]	100 [3.937]	47.8 [1.882]	6 [0.236]	14.5 [0.571]
100333	KLTF-TC64-JS2.0S-100-12	64 [2.520]	100 [3.937]	47.8 [1.882]	12 [0.472]	20.5 [0.807]
101417	KLTF-TC64-JS2.0S-100-25	64 [2.520]	100 [3.937]	47.8 [1.882]	25 [0.984]	33.5 [1.319]
101705	KLTF-TC64-JS2.0S-100-38	64 [2.520]	100 [3.937]	47.8 [1.882]	38 [1.496]	46.5 [1.831]
101706	KLTF-TC64-JS2.0S-100-51	64 [2.520]	100 [3.937]	47.8 [1.882]	51 [2.008]	59.5 [2.343]
TC77 - For pipe JS2.5 (63.5x2.0)						
101707	KLTF-TC77-JS2.5S-112-6	77.5 [3.051]	112 [4.409]	59.5 [2.343]	6 [0.236]	14.5 [0.571]
100332	KLTF-TC77-JS2.5S-112-12	77.5 [3.051]	112 [4.409]	59.5 [2.343]	12 [0.472]	20.5 [0.807]
101708	KLTF-TC77-JS2.5S-112-25	77.5 [3.051]	112 [4.409]	59.5 [2.343]	25 [0.984]	33.5 [1.319]
101709	KLTF-TC77-JS2.5S-112-38	77.5 [3.051]	112 [4.409]	59.5 [2.343]	38 [1.496]	46.5 [1.831]
101710	KLTF-TC77-JS2.5S-112-51	77.5 [3.051]	112 [4.409]	59.5 [2.343]	51 [2.008]	59.5 [2.343]
TC91 - For pipe JS3.0 (76.3x2.0)						
100634	KLTF-TC91-JS3.0S-131-6	91 [3.583]	131 [5.157]	72.3 [2.846]	6 [0.236]	14.5 [0.571]
101711	KLTF-TC91-JS3.0S-131-12	91 [3.583]	131 [5.157]	72.3 [2.846]	12 [0.472]	20.5 [0.807]
101712	KLTF-TC91-JS3.0S-131-25	91 [3.583]	131 [5.157]	72.3 [2.846]	25 [0.984]	33.5 [1.319]
101713	KLTF-TC91-JS3.0S-131-38	91 [3.583]	131 [5.157]	72.3 [2.846]	38 [1.496]	46.5 [1.831]
101714	KLTF-TC91-JS3.0S-131-51	91 [3.583]	131 [5.157]	72.3 [2.846]	51 [2.008]	59.5 [2.343]

Kest-Lock Tank Flange

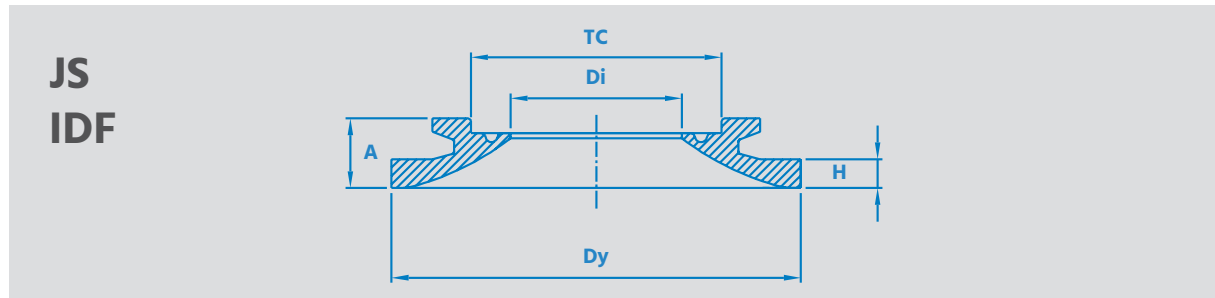

REF. NO	PRODUCT CODE	TC mm [in]	DY mm [in]	DI mm [in]	H mm [in]	A mm [in]
TC106 - For pipe JS3.5 (89.1x2.0)						
101715	KLTF-TC106-JS3.5S-146-6	106 [4.173]	146 [5.748]	85.1 [3.350]	6 [0.236]	14.5 [0.571]
101716	KLTF-TC106-JS3.5S-146-12	106 [4.173]	146 [5.748]	85.1 [3.350]	12 [0.472]	20.5 [0.807]
101717	KLTF-TC106-JS3.5S-146-25	106 [4.173]	146 [5.748]	85.1 [3.350]	25 [0.984]	33.5 [1.319]
101718	KLTF-TC106-JS3.5S-146-38	106 [4.173]	146 [5.748]	85.1 [3.350]	38 [1.496]	46.5 [1.831]
101719	KLTF-TC106-JS3.5S-146-51	106 [4.173]	146 [5.748]	85.1 [3.350]	51 [2.008]	59.5 [2.343]

Tank Flange Welding Tool

PRODUCT CODE	MATERIAL	TC	
		mm	[in]
Welding tool for KLTF			
KLWT-TC25-[Standard]-[H]	Aluminium	25	0.984
KLWT-TC34-[Standard]-[H]	Aluminium	34	1.339
KLWT-TC50-[Standard]-[H]	Aluminium	50.5	1.988
KLWT-TC64-[Standard]-[H]	Aluminium	64	2.520
KLWT-TC77-[Standard]-[H]	Aluminium	77.5	3.051
KLWT-TC91-[Standard]-[H]	Aluminium	91	3.583
KLWT-TC106-[Standard]-[H]	Aluminium	106	4.173
KLWT-TC119-[Standard]-[H]	Aluminium	119	4.685



Welding tool

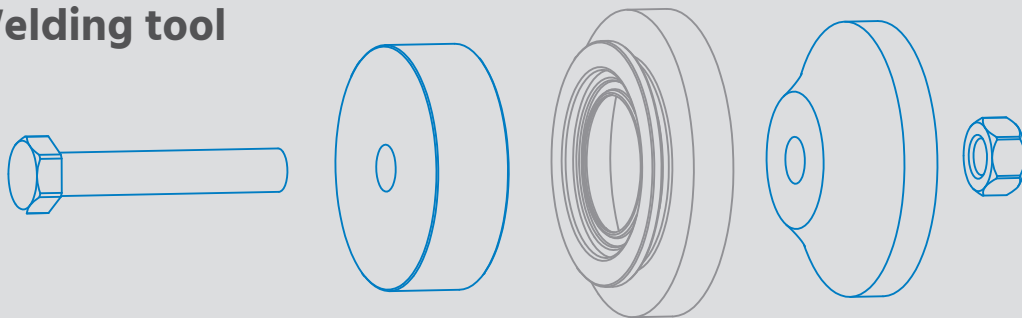

EXAMPLE:

Welding tool for KLTF-TC64-^{Standard}ASTM2.0-100-^H25 = KLWT-TC64-^{Standard}ASTM2.0-^H25



ALWAYS USE A WELDING TOOL AND FOLLOW THE WELDING GUIDE LINE WHEN INSTALLING A KEST-LOCK TANK FLANGE

Kest-Lock Pipe Flange

SPECIFICATIONS

Material grade	EN 1.4404	ASTM 316L or ASME 316L
Material requirement	EN 10 272/10028-7	A479/A240 or SA479/SA240
Documentation	Heat Certificate 3.1 acc. to EN 10 204	
Surface finish	Ra≤[0.5 μm] [20 μin] internal (polished)	Ra≤[1.6 μm] [63 μin] outer
Design temperature	[-80°C to 200°C] [112°F to 392°F]	
Design pressure	[-1 bar(g) to + 10 bar(g)] [-14.5 psi to 145 psi]	
Marking	Marked with material grade and heat number	
Packing	Sealed in vacuum plastic bag, labelled with art. number and packed in a box	
Gaskets	The Kest-Lock is designed for use of standard gaskets acc. to ISO 2852 type B	
Standard	The Kest-Lock is designed for clamp couplings acc ISO 2852, ASME BPE, DIN 32 676	
Quality assurance	Each product is controlled and tested acc. to Kest Technology quality assurance system	

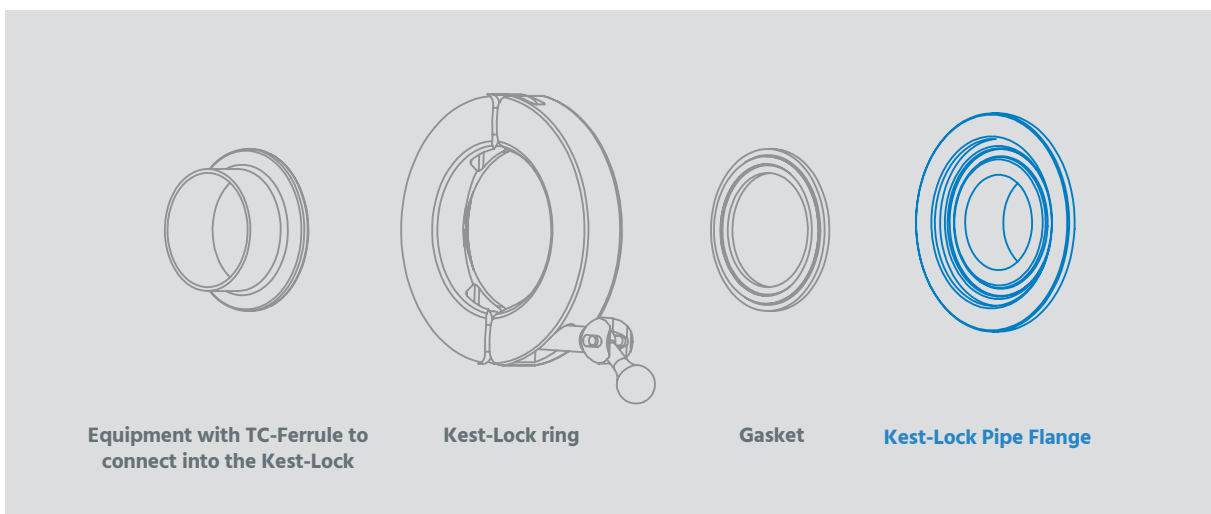
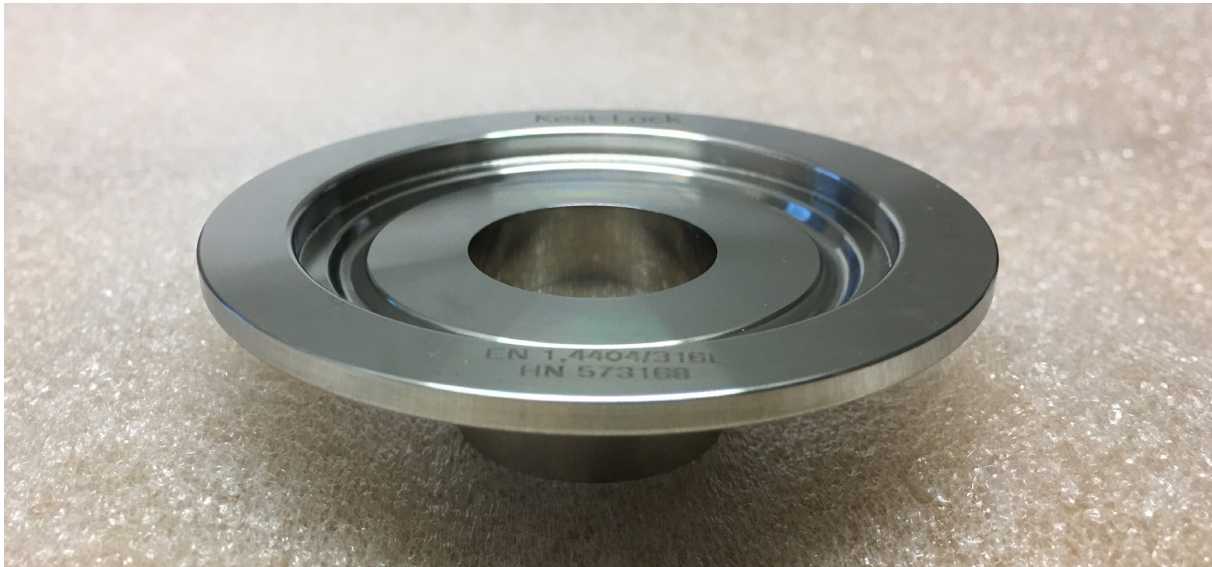

Kest-Lock Pipe Flange

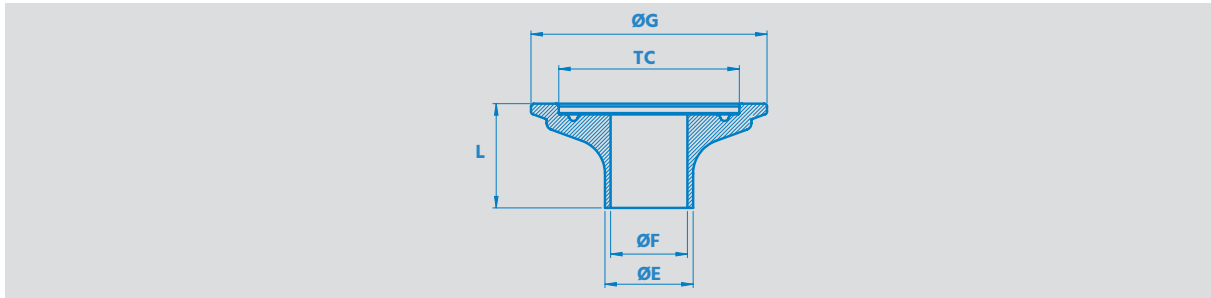

REF. NO	PRODUCT CODE	TC mm [in]	ØE mm [in]	ØF mm [in]	ØG mm [in]	L mm [in]
For pipe ASTM 269/270						
102293	KLPF-TC25-ASTM0.5-30	25 [0.984]	12.7 [0.500]	9.4 [0.370]	42.5 [1.673]	30 [1.181]
102294	KLPF-TC25-ASTM0.75-30	25 [0.984]	19.1 [0.750]	15.8 [0.622]	42.5 [1.673]	30 [1.181]
102295	KLPF-TC50-ASTM1.0-30	50.5 [1.988]	25.4 [1.000]	22.1 [0.870]	68 [2.677]	30 [1.181]
102296	KLPF-TC50-ASTM1.5-30	50.5 [1.988]	38.1 [1.500]	34.8 [1.370]	68 [2.677]	30 [1.181]
102297	KLPF-TC64-ASTM2.0-30	64 [2.520]	50.8 [2.000]	47.5 [1.870]	81.5 [3.209]	30 [1.181]
102298	KLPF-TC77-ASTM2.5-30	77.5 [3.051]	63.5 [2.500]	60.2 [2.370]	95 [3.740]	30 [1.181]
102299	KLPF-TC91-ASTM3.0-30	91 [3.583]	76.2 [3.000]	72.9 [2.870]	108.5 [4.272]	30 [1.181]
102300	KLPF-TC119-ASTM4.0-30	119 [4.685]	101.6 [4.000]	97.4 [3.835]	136.5 [5.374]	30 [1.181]
For pipe ISO 1127						
102301	KLPF-TC25-ISO8-30	25 [0.984]	13.5 [0.532]	10.3 [0.406]	42.5 [1.673]	30 [1.181]
102302	KLPF-TC34-ISO10-30	34 [1.339]	17.2 [0.677]	14 [0.551]	51.5 [2.028]	30 [1.181]
102303	KLPF-TC34-ISO15-30	34 [1.339]	21.3 [0.839]	18.1 [0.713]	51.5 [2.028]	30 [1.181]
102304	KLPF-TC50-ISO20-30	50.5 [1.988]	26.9 [1.059]	23.7 [0.933]	68 [2.677]	30 [1.181]
102305	KLPF-TC50-ISO25-30	50.5 [1.988]	33.7 [1.327]	29.7 [1.169]	68 [2.677]	30 [1.181]
102306	KLPF-TC64-ISO32-30	64 [2.520]	42.3 [1.665]	38.3 [1.508]	81.5 [3.209]	30 [1.181]
102307	KLPF-TC64-ISO40-30	64 [2.520]	48.3 [1.902]	44.3 [1.744]	81.5 [3.209]	30 [1.181]
102308	KLPF-TC77-ISO50-30	77.5 [3.051]	60.3 [2.374]	56.3 [2.217]	95 [3.740]	30 [1.181]
102309	KLPF-TC91-ISO65-30	91 [3.583]	76.3 [3.004]	71.5 [2.815]	108.5 [4.272]	30 [1.181]

Kest-Lock Pipe Flange

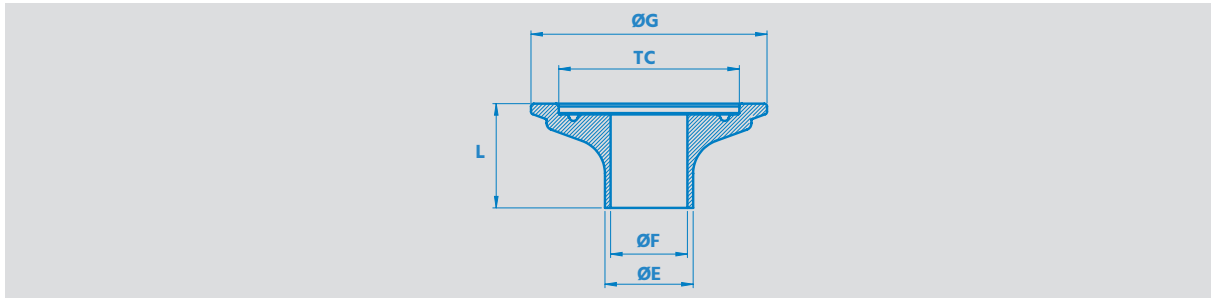

REF. NO	PRODUCT CODE	TC mm [in]	ØE mm [in]	ØF mm [in]	ØG mm [in]	L mm [in]
For pipe EN 10357-A (DIN 11850-R2)						
102310	KLPF-TC34-EN10-2-30	34 [1.339]	13 [0.512]	10 [0.394]	51.5 [2.028]	30 [1.181]
102311	KLPF-TC34-EN15-2-30	34 [1.339]	19 [0.748]	16 [0.630]	51.5 [2.028]	30 [1.181]
102312	KLPF-TC34-EN20-2-30	34 [1.339]	23 [0.906]	20 [0.787]	51.5 [2.028]	30 [1.181]
102313	KLPF-TC50-EN25-2-30	50.5 [1.988]	29 [1.142]	26 [1.024]	68 [2.677]	30 [1.181]
102314	KLPF-TC50-EN32-2-30	50.5 [1.988]	35 [1.378]	32 [1.260]	68 [2.677]	30 [1.181]
102315	KLPF-TC50-EN40-2-30	50.5 [1.988]	41 [1.614]	38 [1.496]	68 [2.677]	30 [1.181]
102316	KLPF-TC64-EN50-2-30	64 [2.520]	53 [2.087]	50 [1.969]	81.5 [3.209]	30 [1.181]
102317	KLPF-TC91-EN65-1-30	91 [3.583]	70 [2.756]	66 [2.598]	108.5 [4.272]	30 [1.181]
102318	KLPF-TC119-EN100-1-30	119 [4.685]	104 [4.094]	100 [3.937]	136.5 [5.374]	30 [1.181]
For pipe SMS 3008						
102319	KLPF-TC25-SMS12-30	25 [0.984]	12.0 [0.472]	10 [0.394]	42.5 [1.673]	30 [1.181]
102320	KLPF-TC25-SMS18-30	25 [0.984]	18.0 [0.709]	15.0 [0.591]	42.5 [1.673]	30 [1.181]
102321	KLPF-TC50-SMS25-30	50.5 [1.988]	25.0 [0.984]	22.6 [0.890]	68 [2.677]	30 [1.181]
102322	KLPF-TC50-SMS38-30	50.5 [1.988]	38 [1.496]	35.6 [1.402]	68 [2.677]	30 [1.181]
102323	KLPF-TC64-SMS51-30	64 [2.520]	51.0 [2.008]	48.6 [1.913]	81.5 [3.209]	30 [1.181]
102324	KLPF-TC77-SMS63-30	77.5 [3.051]	63.5 [2.500]	60.3 [2.374]	95 [3.740]	30 [1.181]
102325	KLPF-TC91-SMS76-30	91 [3.583]	76.1 [2.996]	72.9 [2.870]	108.5 [4.272]	30 [1.181]

Kest-Lock Pipe Flange

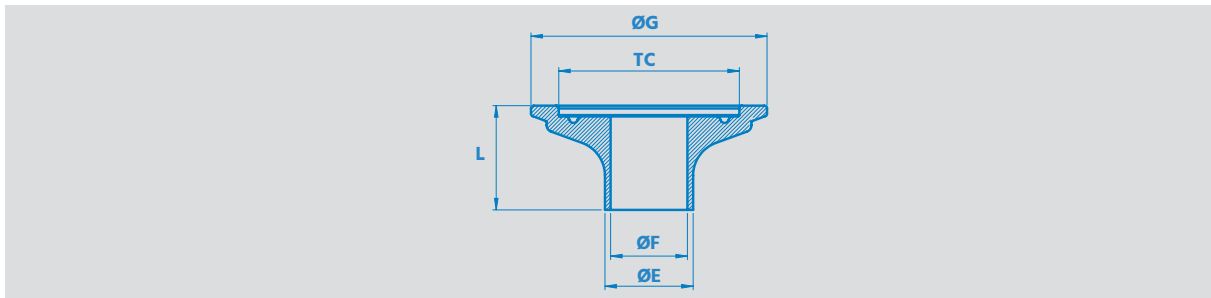

REF. NO	PRODUCT CODE	TC mm [in]	ØE mm [in]	ØF mm [in]	ØG mm [in]	L mm [in]
For pipe JS IDF						
102326	KLPF-TC50-JS1.0S-30	50.5 [1.988]	25.4 [1.000]	23 [0.906]	68 [2.677]	30 [1.181]
102327	KLPF-TC50-JS1.25S-30	50.5 [1.988]	31.8 [1.252]	29.4 [1.157]	68 [2.677]	30 [1.181]
102328	KLPF-TC50-JS1.5S-30	50.5 [1.988]	38.1 [1.500]	35.7 [1.406]	68 [2.677]	30 [1.181]
102329	KLPF-TC64-JS2.0S-30	64 [2.520]	50.8 [2.000]	47.8 [1.882]	81.5 [3.209]	30 [1.181]
102330	KLPF-TC77-JS2.5S-30	77.5 [3.051]	63.5 [2.500]	59.5 [2.343]	95 [3.740]	30 [1.181]
102331	KLPF-TC91-JS3.0S-30	91 [3.583]	76.3 [3.004]	72.3 [2.846]	108.5 [4.272]	30 [1.181]
102332	KLPF-TC106-JS3.5S-30	106 [4.173]	89.1 [3.508]	85.1 [3.350]	121.5 [4.783]	30 [1.181]

Kest-Lock Pipe Adapter Flange

SPECIFICATIONS

Material Grade	EN 1.4404	ASTM 316L or ASME 316L
Material requirement	EN 10 272/10028-7	A479/A240 or SA479/SA240
Documentation	Heat Certificate 3.1 acc. to EN 10 204	
Surface finish	Ra≤[0.5 μm] [20 μin] internal (polished)	Ra≤[1.6 μm] [63 μin] outer
Design Temperature	[-80°C to 200°C] [112°F to 392°F]	
Design Pressure	[-1 bar(g) to + 10 bar(g)] [-14.5 psi to 145 psi]	
Marking	Marked with material grade and heat number	
Packing	Sealed in vacuum plastic bag, labelled with art. number and packed in a box	
Gaskets	The Kest-Lock is designed for use of standard gaskets acc. to ISO 2852 type B	
Standard	The Kest-Lock is designed for clamp couplings acc ISO 2852, ASME BPE, DIN 32 676	
Quality Assurance	Each product is controlled and tested acc. to Kest Technology quality assurance system	

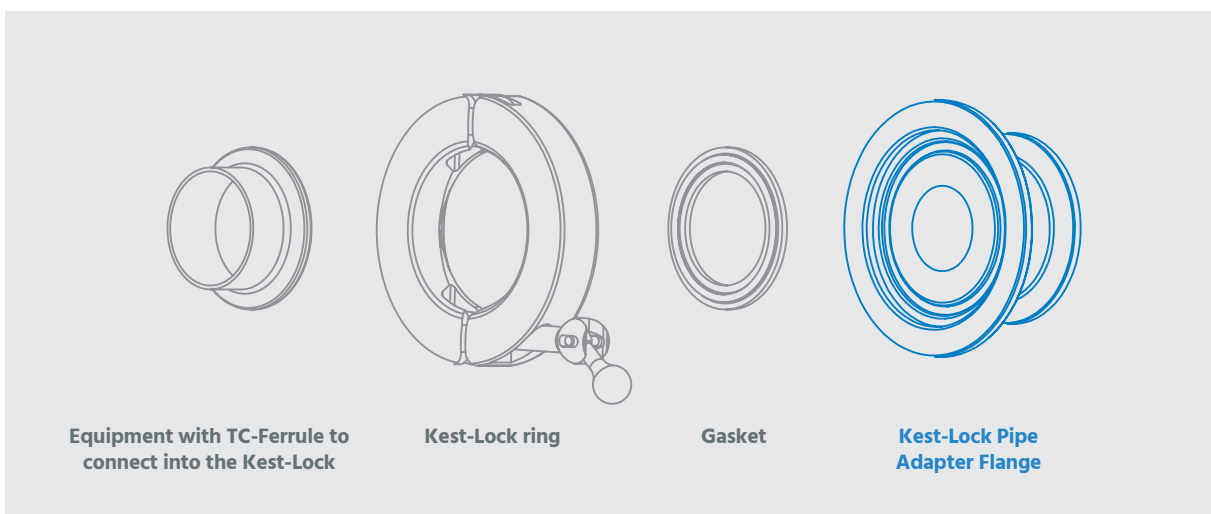
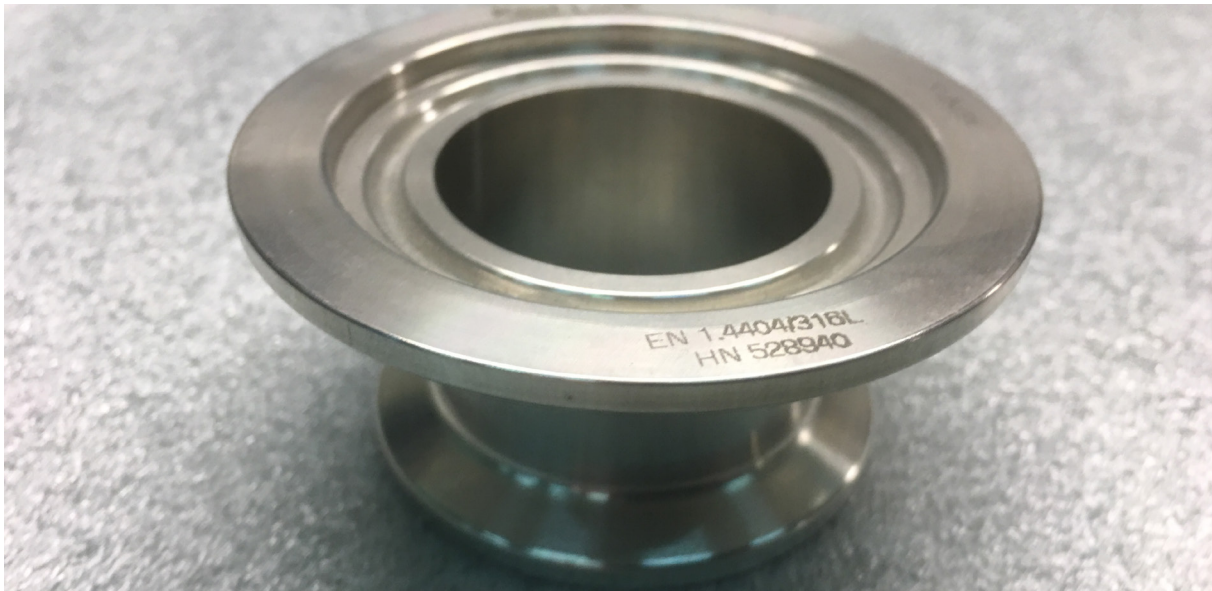

Kest-Lock Pipe Adapter Flange

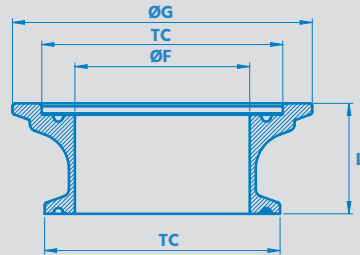

REF. NO	PRODUCT CODE	TC mm [in]	ØF mm [in]	ØG mm [in]	L mm [in]
For pipe ASTM A 269/270					
101722	KLPAF-TC25-ASTM0.5-30	25 [0.984]	9.4 [0.370]	42.5 [1.673]	30 [1.181]
100486	KLPAF-TC25-ASTM0.75-30	25 [0.984]	15.8 [0.622]	42.5 [1.673]	30 [1.181]
100254	KLPAF-TC50-ASTM1.0-30	50.5 [1.988]	22.1 [0.870]	68 [2.677]	30 [1.181]
100251	KLPAF-TC50-ASTM1.5-30	50.5 [1.988]	34.8 [1.370]	68 [2.677]	30 [1.181]
100245	KLPAF-TC64-ASTM2.0-30	64 [2.520]	47.5 [1.870]	81.5 [3.209]	30 [1.181]
101386	KLPAF-TC77-ASTM2.5-30	77.5 [3.051]	60.2 [2.370]	95 [3.740]	30 [1.181]
101723	KLPAF-TC91-ASTM3.0-30	91 [3.583]	72.9 [2.870]	108.5 [4.272]	30 [1.181]
101724	KLPAF-TC119-ASTM4.0-30	119 [4.685]	97.4 [3.835]	136.5 [5.374]	30 [1.181]
For pipe ISO 1127					
101725	KLPAF-TC25-ISO8-30	25 [0.984]	10.3 [0.406]	42.5 [1.673]	30 [1.181]
101726	KLPAF-TC34-ISO10-30	34 [1.339]	14 [0.551]	51.5 [2.028]	30 [1.181]
101727	KLPAF-TC34-ISO15-30	34 [1.339]	18.1 [0.713]	51.5 [2.028]	30 [1.181]
101731	KLPAF-TC50-ISO20-30	50.5 [1.988]	23.7 [0.933]	68 [2.677]	30 [1.181]
101732	KLPAF-TC50-ISO25-30	50.5 [1.988]	29.7 [1.169]	68 [2.677]	30 [1.181]
101733	KLPAF-TC64-ISO32-30	64 [2.520]	38.3 [1.508]	81.5 [3.209]	30 [1.181]
101734	KLPAF-TC64-ISO40-30	64 [2.520]	44.3 [1.744]	81.5 [3.209]	30 [1.181]
101735	KLPAF-TC77-ISO50-30	77.5 [3.051]	56.3 [2.217]	95 [3.740]	30 [1.181]
101736	KLPAF-TC91-ISO65-30	91 [3.583]	71.5 [2.815]	108.5 [4.272]	30 [1.181]

Kest-Lock Pipe Adapter Flange

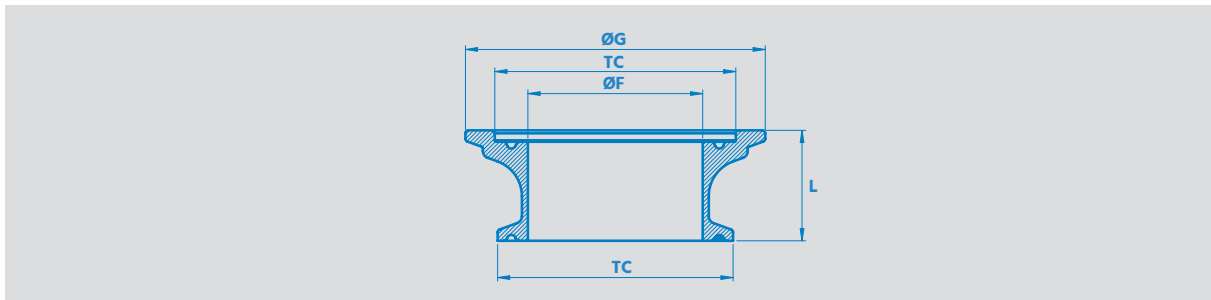

REF. NO	PRODUCT CODE	TC mm [in]	ØF mm [in]	ØG mm [in]	L mm [in]
For pipe EN 10357-A (DIN 11850-R2)					
101737	KLPAF-TC34-EN10-30	34 [1.339]	10 [0.394]	51.5 [2.028]	30 [1.181]
101738	KLPAF-TC34-EN15-30	34 [1.339]	16 [0.630]	51.5 [2.028]	30 [1.181]
100349	KLPAF-TC34-EN20-30	34 [1.339]	20 [0.787]	51.5 [2.028]	30 [1.181]
100331	KLPAF-TC50-EN25-30	50.5 [1.988]	26 [1.024]	68 [2.677]	30 [1.181]
101739	KLPAF-TC50-EN32-30	50.5 [1.988]	32 [1.260]	68 [2.677]	30 [1.181]
101740	KLPAF-TC50-EN40-30	50.5 [1.988]	38 [1.496]	68 [2.677]	30 [1.181]
101041	KLPAF-TC64-EN50-30	64 [2.520]	50 [1.969]	81.5 [3.209]	30 [1.181]
101741	KLPAF-TC91-EN65-30	91 [3.583]	66 [2.598]	108.5 [4.272]	30 [1.181]
101743	KLPAF-TC119-EN100-30	119 [4.685]	100 [3.937]	136.5 [5.374]	30 [1.181]
For pipe SMS 3008					
100315	KLPAF-TC25-SMS12-30	25 [0.984]	10 [0.394]	42.5 [1.673]	30 [1.181]
101720	KLPAF-TC25-SMS18-30	25 [0.984]	15.0 [0.591]	42.5 [1.673]	30 [1.181]
100252	KLPAF-TC50-SMS25-30	50.5 [1.988]	22.6 [0.890]	68 [2.677]	30 [1.181]
100246	KLPAF-TC50-SMS38-30	50.5 [1.988]	35.6 [1.402]	68 [2.677]	30 [1.181]
100234	KLPAF-TC64-SMS51-30	64 [2.520]	48.6 [1.913]	81.5 [3.209]	30 [1.181]
101721	KLPAF-TC77-SMS63-30	77.5 [3.051]	60.3 [2.374]	95 [3.740]	30 [1.181]
100271	KLPAF-TC91-SMS76-30	91 [3.583]	72.9 [2.870]	108.5 [4.272]	30 [1.181]

Kest-Lock Pipe Adapter Flange

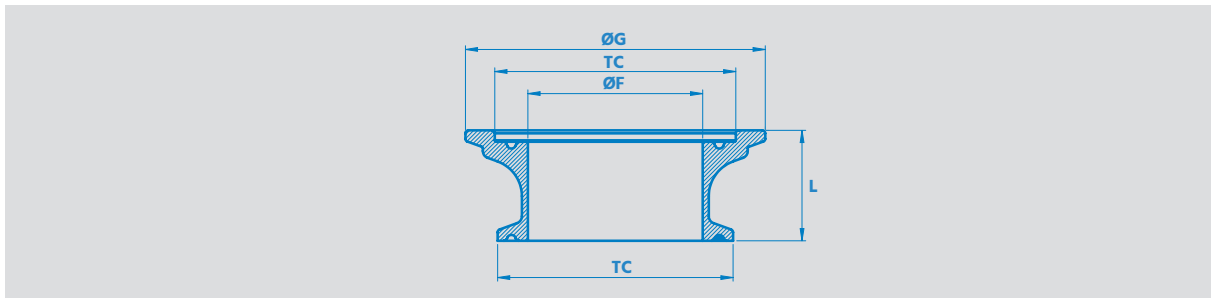

REF. NO	PRODUCT CODE	TC mm [in]	ØF mm [in]	ØG mm [in]	L mm [in]
For pipe JS IDF					
101744	KLPAF-TC50-JS1.0S-30	50.5 [1.988]	23 [0.906]	68 [2.677]	30 [1.181]
101745	KLPAF-TC50-JS1.25S-30	50.5 [1.988]	29.4 [1.157]	68 [2.677]	30 [1.181]
101746	KLPAF-TC50-JS1.5S-30	50.5 [1.988]	35.7 [1.406]	68 [2.677]	30 [1.181]
101747	KLPAF-TC64-JS2.0S-30	64 [2.520]	47.8 [1.882]	81.5 [3.209]	30 [1.181]
101748	KLPAF-TC77-JS2.5S-30	77.5 [3.051]	59.5 [2.343]	95 [3.740]	30 [1.181]
101749	KLPAF-TC91-JS3.0S-30	91 [3.583]	72.3 [2.846]	108.5 [4.272]	30 [1.181]
101750	KLPAF-TC106-JS3.5S-30	106 [4.173]	85.1 [3.350]	121.5 [4.783]	30 [1.181]

Kest-Lock Pipe Panel Flange

SPECIFICATIONS

Material Grade	EN 1.4404	ASTM 316L or ASME 316L
Material requirement	EN 10 272/10028-7	A479/A240 or SA479/SA240
Documentation	Heat Certificate 3.1 acc. to EN 10 204	
Surface finish	Ra≤[0.5 μm] [20 μin] internal (polished)	Ra≤[1.6 μm] [63 μin] outer
Design Temperature	[-80°C to 200°C] [112°F to 392°F]	
Design Pressure	[-1 bar(g) to + 10 bar(g)] [-14.5 psi to 145 psi]	
Marking	Marked with material grade and heat number	
Packing	Sealed in vacuum plastic bag, labelled with art. number and packed in a box	
Gaskets	The Kest-Lock is designed for use of standard gaskets acc. to ISO 2852 type B	
Standard	The Kest-Lock is designed for clamp couplings acc ISO 2852, ASME BPE, DIN 32 676	
Quality Assurance	Each product is controlled and tested acc. to Kest Technology quality assurance system	

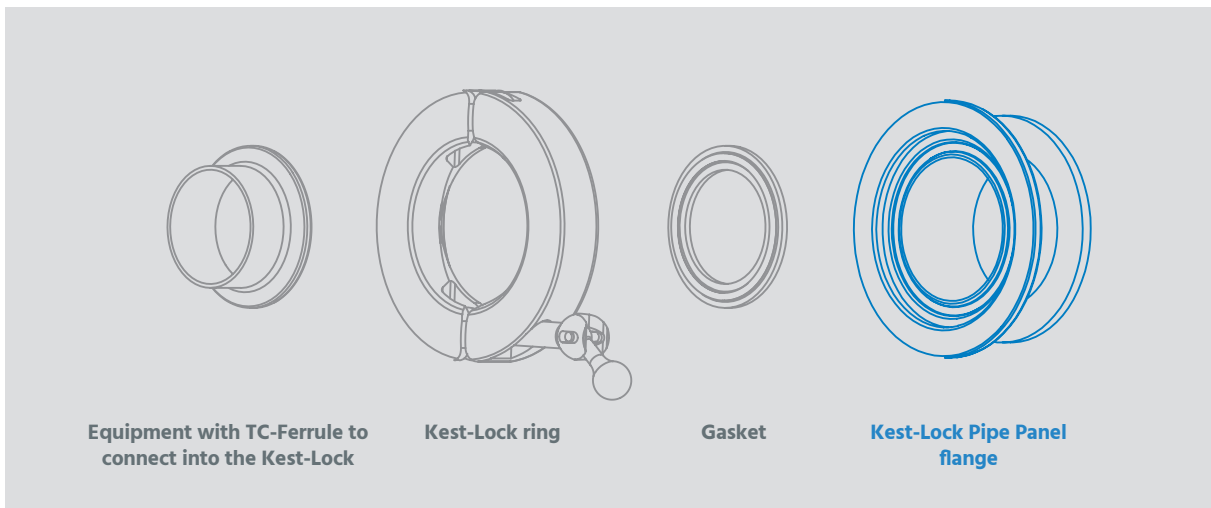

Kest-Lock Pipe Panel Flange

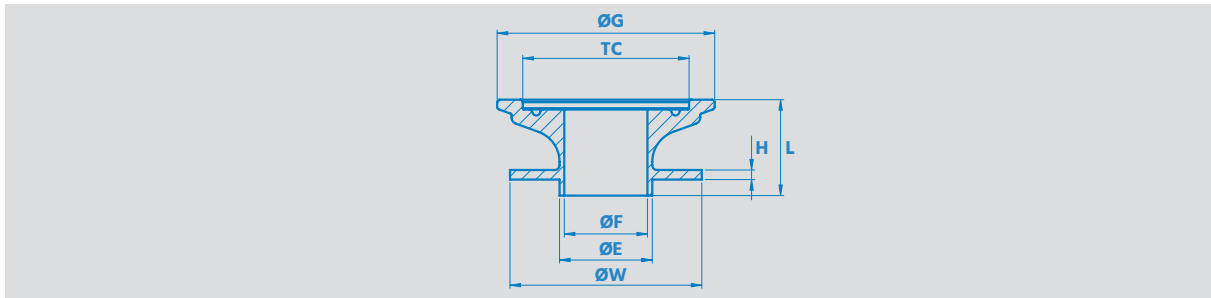

REF. NO	PRODUCT CODE	TC mm [in]	ØE mm [in]	ØF mm [in]	ØW mm [in]	H mm [in]	ØG mm [in]	L mm [in]
For pipe ASTM A 269/270								
102333	KLPPF-TC25-ASTM0.75-30	25 [0.984]	19.1 [0.750]	15.8 [0.622]	40 [1.575]	3 [0.118]	42.5 [1.673]	30 [1.181]
102334	KLPPF-TC50-ASTM1.0-30	50.5 [1.988]	25.4 [1.000]	22.1 [0.870]	60 [2.362]	3 [0.118]	68 [2.677]	30 [1.181]
102335	KLPPF-TC50-ASTM1.5-30	50.5 [1.988]	38.1 [1.500]	34.8 [1.370]	60 [2.362]	3 [0.118]	68 [2.677]	30 [1.181]
102336	KLPPF-TC64-ASTM2.0-30	64 [2.520]	50.8 [2.000]	47.5 [1.870]	70 [2.756]	3 [0.118]	81.5 [3.209]	30 [1.181]
For pipe ISO 1127								
102337	KLPPF-TC34-ISO15-30	34 [1.339]	21.3 [0.839]	18.1 [0.713]	40 [1.575]	3 [0.118]	51.5 [2.028]	30 [1.181]
102338	KLPPF-TC50-ISO25-30	50.5 [1.988]	33.7 [1.327]	29.7 [1.169]	60 [2.362]	3 [0.118]	68 [2.677]	30 [1.181]
102339	KLPPF-TC64-ISO40-30	64 [2.520]	48.3 [1.902]	44.3 [1.744]	70 [2.756]	3 [0.118]	81.5 [3.209]	30 [1.181]
For pipe EN 10357-A (DIN 11850-R2)								
101517	KLPPF-TC34-EN15-30	34 [1.339]	19 [0.748]	16 [0.630]	40 [1.575]	3 [0.118]	51.5 [2.028]	30 [1.181]
101498	KLPPF-TC34-EN20-30	34 [1.339]	23 [0.906]	20 [0.787]	40 [1.575]	3 [0.118]	51.5 [2.028]	30 [1.181]
101499	KLPPF-TC50-EN25-30	50.5 [1.988]	29 [1.142]	26 [1.024]	60 [2.362]	3 [0.118]	68 [2.677]	30 [1.181]

Kest-Lock Pipe Inline

SPECIFICATIONS

Material Grade	EN 1.4435	ASTM 316L or ASME 316L
Material requirement	EN 10 272/10028-7	A479/A240 or SA479/SA240
Documentation	Heat Certificate 3.1 acc. to EN 10 204	
Surface finish	Ra≤[0.5 μm] [20 μin] internal (polished)	Ra≤[1.6 μm] [63 μin] outer
Design Temperature	[-80°C to 200°C] [112°F to 392°F]	
Design Pressure	[-1 bar(g) to + 10 bar(g)] [-14.5 psi to 145 psi]	
Marking	Marked with material grade and heat number	
Packing	Sealed in vacuum plastic bag, labelled with art. number and packed in a box	
Gaskets	The Kest-Lock is designed for use of standard gaskets acc. to ISO 2852 type B	
Standard	The Kest-Lock is designed for clamp couplings acc ISO 2852, ASME BPE, DIN 32 676	
Quality Assurance	Each product is controlled and tested acc. to Kest Technology quality assurance system	

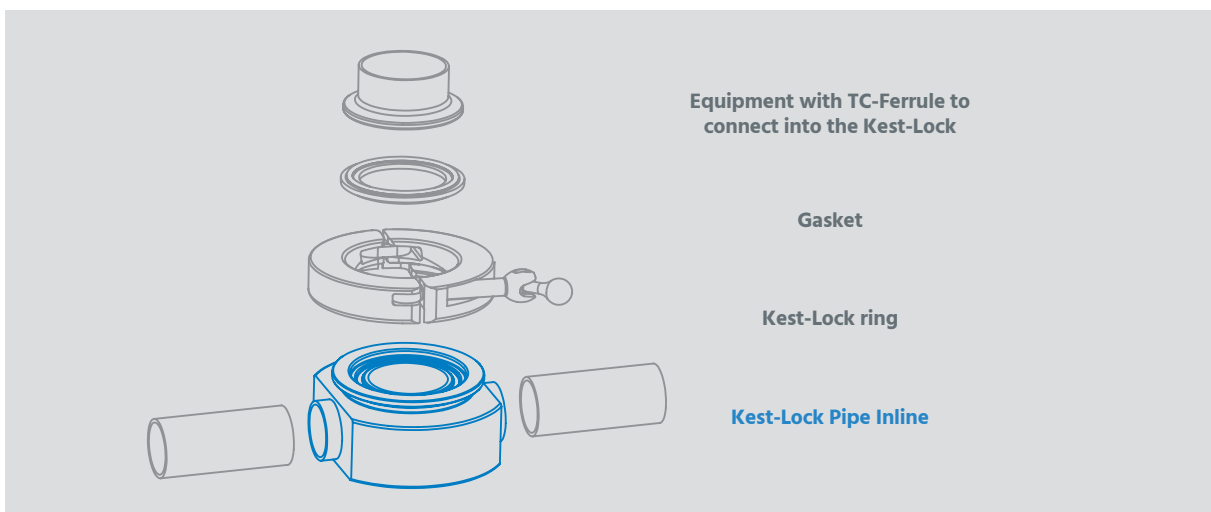

Kest-Lock Pipe Inline

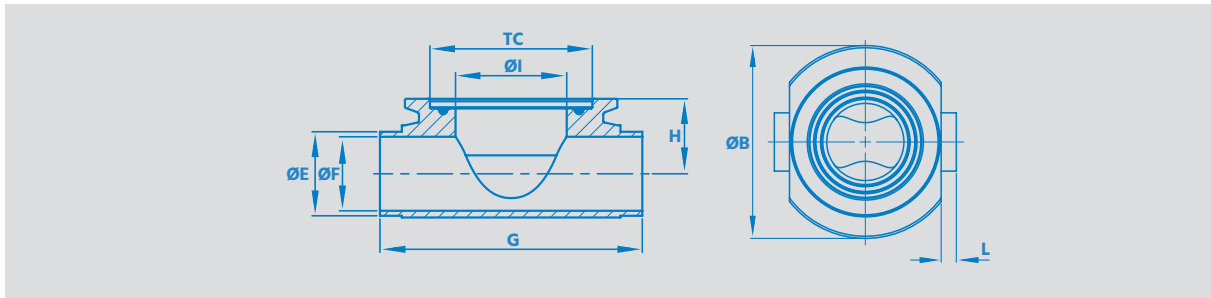

REF. NO	PRODUCT CODE	TC mm [in]	ØI mm [in]	ØE mm [in]	ØF mm [in]	G mm [in]	H mm [in]	L mm [in]	ØB mm [in]
For pipe ASTM A 269/270									
100426	KLPI-TC50-ASTM1.5-ASTM0.5-BE	50.5 [1.988]	34.8 [1.370]	12.7 [0.500]	9.4 [0.370]	112 [4.409]	16.05 [0.632]	21 [0.827]	85 [3.346]
100312	KLPI-TC50-ASTM1.5-ASTM0.75-BE	50.5 [1.988]	34.8 [1.370]	19.1 [0.750]	15.8 [0.622]	112 [4.409]	20 [0.787]	21 [0.827]	85 [3.346]
100311	KLPI-TC50-ASTM1.5-ASTM1.0-BE	50.5 [1.988]	34.8 [1.370]	25.4 [1.000]	22.1 [0.870]	112 [4.409]	22.4 [0.882]	21 [0.827]	85 [3.346]
100313	KLPI-TC50-ASTM1.5-ASTM1.5-BE	50.5 [1.988]	34.8 [1.370]	38.1 [1.500]	34.8 [1.370]	112 [4.409]	28.75 [1.132]	21 [0.827]	88 [3.465]
100513	KLPI-TC50-ASTM1.5-ASTM2.0-BE	50.5 [1.988]	34.8 [1.370]	50.8 [2.000]	47.5 [1.870]	112 [4.409]	35.1 [1.382]	21 [0.827]	93 [3.661]
100745	KLPI-TC50-ASTM1.5-ASTM2.5-BE	50.5 [1.988]	34.8 [1.370]	63.5 [2.500]	60.2 [2.370]	112 [4.409]	41.45 [1.632]	21 [0.827]	100 [3.937]

Kest-Lock Pipe Inline Double

SPECIFICATIONS

Material Grade	EN 1.4435	ASTM 316L or ASME 316L
Material requirement	EN 10 272/10028-7	A479/A240 or SA479/SA240
Documentation	Heat Certificate 3.1 acc. to EN 10 204	
Surface finish	Ra≤[0.5 μm] [20 μin] internal (polished)	Ra≤[1.6 μm] [63 μin] outer
Design Temperature	[-80°C to 200°C] [112°F to 392°F]	
Design Pressure	[-1 bar(g) to + 10 bar(g)] [-14.5 psi to 145 psi]	
Marking	Marked with material grade and heat number	
Packing	Sealed in vacuum plastic bag, labelled with art. number and packed in a box	
Gaskets	The Kest-Lock is designed for use of standard gaskets acc. to ISO 2852 type B	
Standard	The Kest-Lock is designed for clamp couplings acc ISO 2852, ASME BPE, DIN 32 676	
Quality Assurance	Each product is controlled and tested acc. to Kest Technology quality assurance system	

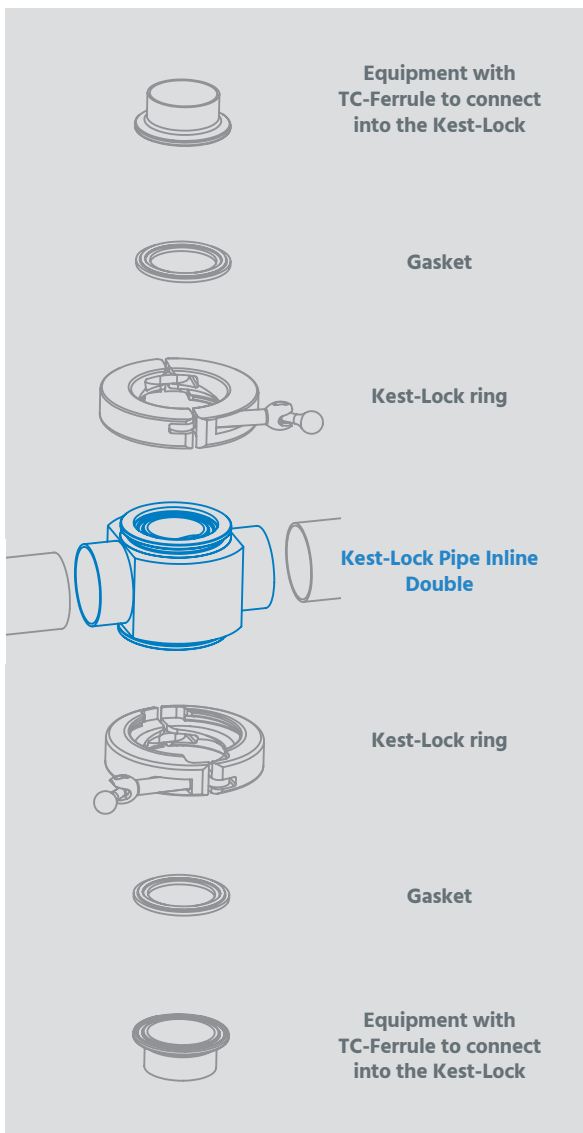

Kest Lock Pipe Inline Double

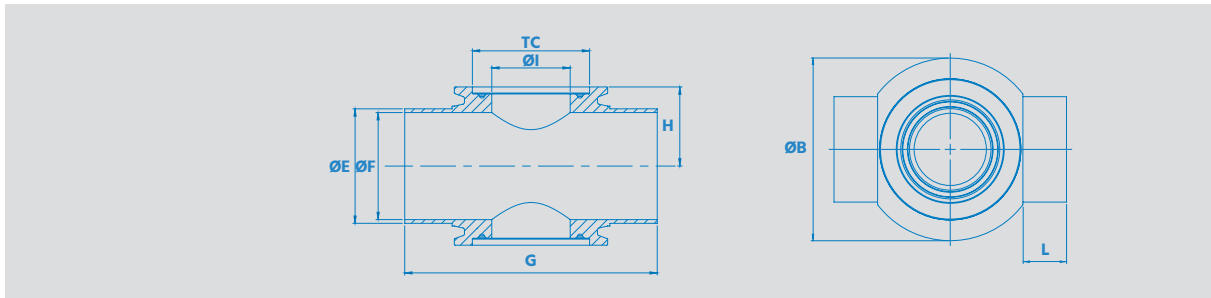

REF. NO	PRODUCT CODE	TC mm [in]	ØI mm [in]	ØE mm [in]	ØF mm [in]	G mm [in]	H mm [in]	L mm [in]	ØB mm [in]
For pipe ASTM A 269/270									
100425	KLPID-TC50-ASTM1.5-ASTM0.50-BE	50.5 [1.988]	34.8 [1.370]	12.7 [0.500]	9.4 [0.370]	112 [4.409]	16.05 [0.632]	21 [0.827]	85 [3.346]
100320	KLPID-TC50-ASTM1.5-ASTM0.75-BE	50.5 [1.988]	34.8 [1.370]	19.1 [0.750]	15.8 [0.622]	112 [4.409]	20 [0.787]	21 [0.827]	85 [3.346]
100329	KLPID-TC50-ASTM1.5-ASTM1.0-BE	50.5 [1.988]	34.8 [1.370]	25.4 [1.000]	22.1 [0.870]	112 [4.409]	22.4 [0.882]	21 [0.827]	85 [3.346]
100512	KLPID-TC50-ASTM1.5-ASTM1.5-BE	50.5 [1.988]	34.8 [1.370]	38.1 [1.500]	34.8 [1.370]	112 [4.409]	28.75 [1.132]	21 [0.827]	88 [3.465]
100514	KLPID-TC50-ASTM1.5-ASTM2.0-BE	50.5 [1.988]	34.8 [1.370]	50.8 [2.000]	47.5 [1.870]	112 [4.409]	35.1 [1.382]	21 [0.827]	93 [3.661]
100746	KLPID-TC50-ASTM1.5-ASTM2.5-BE	50.5 [1.988]	34.8 [1.370]	63.5 [2.500]	60.2 [2.370]	112 [4.409]	41.45 [1.632]	21 [0.827]	100 [3.937]

Blind Cap with knob

SPECIFICATIONS

Material Grade	EN 1.4404	ASTM 316L or ASME 316L
Material requirement	EN 10 272/10028-7	A479/A240 or SA479/SA240
Documentation	Heat Certificate 3.1 acc. to EN 10 204	
Surface finish	Ra≤[0.5 μm] [20 μin] internal (polished)	Ra≤[1.6 μm] [63 μin] outer
Design Temperature	[-80°C to 200°C] [112°F to 392°F]	
Design Pressure	[-1 bar(g) to + 10 bar(g)] [-14.5 psi to 145 psi]	
Marking	Marked with material grade and heat number	
Packing	Sealed in a vacuum plastic bag, labelled with art. number and packed in a box	
Gaskets	The Kest-Lock is designed for use of standard gaskets acc. to ISO 2852 type B	
Standard	The Kest-Lock is designed for clamp couplings acc ISO 2852, ASME BPE, DIN 32 676	
Quality Assurance	Each product is controlled and tested acc. to Kest Technology quality assurance system	

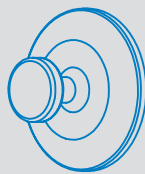

Blind Cap with knob

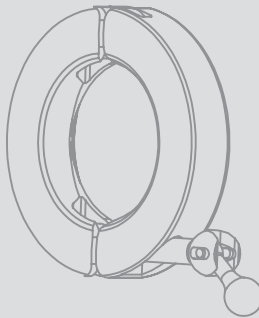

Kest-Lock ring



Gasket

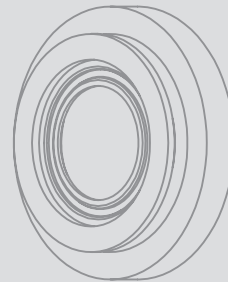

Kest-Lock flange

Blind Cap with knob

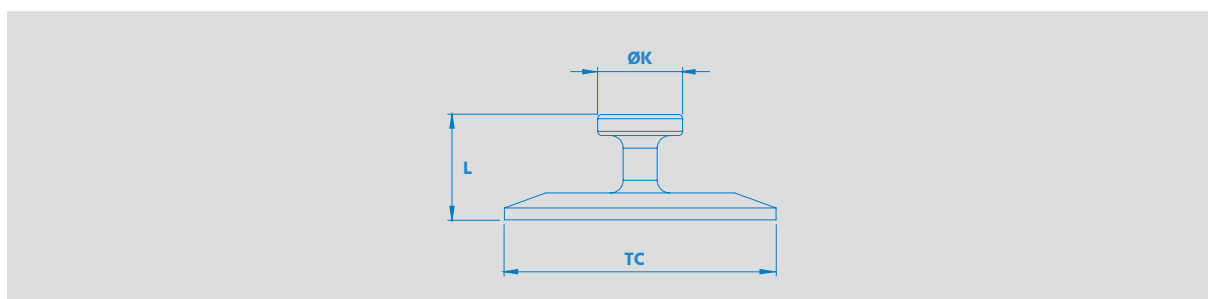

REF. NO	PRODUCT CODE	TC mm [in]	ØK mm [in]	L mm [in]
KLBF				
100220	KLBF-TC25	25 [0.984]	20 [0.787]	25 [0.984]
100221	KLBF-TC34	34 [1.339]	20 [0.787]	25 [0.984]
100222	KLBF-TC50	50.5 [1.988]	20 [0.787]	25 [0.984]
100223	KLBF-TC64	64 [2.520]	20 [0.787]	25 [0.984]
100224	KLBF-TC77	77.5 [3.051]	20 [0.787]	25 [0.984]
100225	KLBF-TC91	91 [3.583]	20 [0.787]	25 [0.984]
100226	KLBF-TC106	106 [4.173]	20 [0.787]	25 [0.984]
100370	KLBF-TC119	119 [4.685]	20 [0.787]	25 [0.984]



kest